

Inquiry AO-2014-006: Robinson R44 II, ZK-HBQ, mast-bump and
in-flight break-up, Kahurangi National Park, 7 October 2014

The Transport Accident Investigation Commission is an independent Crown entity established to determine the circumstances and causes of accidents and incidents with a view to avoiding similar occurrences in the future. Accordingly it is inappropriate that reports should be used to assign fault or blame or determine liability, since neither the investigation nor the reporting process has been undertaken for that purpose.

The Commission may make recommendations to improve transport safety. The cost of implementing any recommendation must always be balanced against its benefits. Such analysis is a matter for the regulator and the industry.

These reports may be reprinted in whole or in part without charge, providing acknowledgement is made to the Transport Accident Investigation Commission.



Final Report

Aviation Inquiry AO-2014-006
Robinson R44 II, ZK-HBQ, mast-bump and
in-flight break-up, Kahurangi National Park,
7 October 2014

Approved for publication: February 2017

Transport Accident Investigation Commission

About the Transport Accident Investigation Commission

The Transport Accident Investigation Commission (Commission) is a standing commission of inquiry and an independent Crown entity responsible for inquiring into maritime, aviation and rail accidents and incidents for New Zealand, and co-ordinating and co-operating with other accident investigation organisations overseas. The principal purpose of its inquiries is to determine the circumstances and causes of occurrences with a view to avoiding similar occurrences in the future. Its purpose is not to ascribe blame to any person or agency or to pursue (or to assist an agency to pursue) criminal, civil or regulatory action against a person or agency. The Commission carries out its purpose by informing members of the transport sector and the public, both domestically and internationally, of the lessons that can be learnt from transport accidents and incidents.

Commissioners

Chief Commissioner	Jane Meares
Deputy Chief Commissioner	Peter McKenzie, QC
Commissioner	Richard Marchant
Commissioner	Stephen Davies Howard

Key Commission personnel

Chief Executive	Lois Hutchinson
Chief Investigator of Accidents	Captain Tim Burfoot
Investigator in Charge	Sam Stephenson
General Counsel	Cathryn Bridge

Email	inquiries@taic.org.nz
Web	www.taic.org.nz
Telephone	+ 64 4 473 3112 (24 hrs) or 0800 188 926
Fax	+ 64 4 499 1510
Address	Level 11, 114 The Terrace, PO Box 10 323, Wellington 6143, New Zealand

Important notes

Nature of the final report

This final report has not been prepared for the purpose of supporting any criminal, civil or regulatory action against any person or agency. The Transport Accident Investigation Commission Act 1990 makes this final report inadmissible as evidence in any proceedings with the exception of a Coroner's inquest.

Ownership of report

This report remains the intellectual property of the Transport Accident Investigation Commission.

This report may be reprinted in whole or in part without charge, provided that acknowledgement is made to the Transport Accident Investigation Commission.

Citations and referencing

Information derived from interviews during the Commission's inquiry into the occurrence is not cited in this final report. Documents that would normally be accessible to industry participants only and not discoverable under the Official Information Act 1982 have been referenced as footnotes only. Other documents referred to during the Commission's inquiry that are publicly available are cited.

Photographs, diagrams, pictures

Unless otherwise specified, photographs, diagrams and pictures included in this final report are provided by, and owned by, the Commission.

Verbal probability expressions

The expressions listed in the following table are used in this report to describe the degree of probability (or likelihood) that an event happened or a condition existed in support of a hypothesis.

Terminology (Adopted from the Intergovernmental Panel on Climate Change)	Likelihood of the occurrence/outcome	Equivalent terms
Virtually certain	> 99% probability of occurrence	Almost certain
Very likely	> 90% probability	Highly likely, very probable
Likely	> 66% probability	Probable
About as likely as not	33% to 66% probability	More or less likely
Unlikely	< 33% probability	Improbable
Very unlikely	< 10% probability	Highly unlikely
Exceptionally unlikely	< 1% probability	



ZK-HBQ R44 II (source: Helicopter Charter Karamea)



Accident flight GPS track (source: Google Earth™)



Location of accident

Source: mapsof.net

Contents

Abbreviations.....	ii
Glossary	iii
Data summary.....	iv
1. Executive summary	1
2. Conduct of the inquiry.....	3
3. Factual information.....	4
3.1. Narrative.....	4
3.2. Personnel information	5
3.3. Aircraft information	5
Robinson helicopter main rotor system.....	6
3.4. Meteorological information	7
3.5. Flight recorders	8
3.6. Wreckage and accident site information.....	8
3.7. Medical and pathological information	12
3.8. Survival aspects	12
3.9. Safety awareness training for pilots flying Robinson helicopters	13
4. Analysis.....	15
4.2. What happened.....	15
In-flight break-up causal factors.....	16
4.3. Low main rotor RPM.....	16
4.4. Abrupt, inappropriate or inadvertent cyclic control movement.....	18
4.5. Low-G in turbulence	19
History of low-G mast-bumping	20
Robinson helicopters	21
New Zealand situation	22
R44 and R66 Models.....	23
4.6. Low-G right roll in Robinson helicopters	24
Aerodynamic and rotor dynamic factors during low-G mast-bumping in severe turbulence.....	26
Low-G recovery techniques.....	29
4.7. Conclusions	32
5. Findings	33
6. Safety actions.....	34
General	34
Safety actions addressing safety issues identified during an inquiry.....	34
Safety actions addressing other safety issues	34
7. Recommendations.....	35
General	35
Previous recommendations.....	35
Watchlist	35
Recommendations.....	36

Recommendation one	36
Recommendation two.....	36
8. Key lessons.....	38
9. Citations.....	39
Appendix 1: Flight tracking data.....	40
Appendix 2: Weather forecasts (ARFOR, TAFs), actual reports (METARs), and SIGMETs.....	41
Appendix 3: NTSB special investigation.....	43
Appendix 4: Two-bladed, semi-rigid teetering rotor system dynamics.....	47
Appendix 5: Robinson in-flight break-ups in New Zealand	50
R22 Low-G mast bumping non-fatal incidents.....	51
Appendix 6: Robinson Safety Notices	52
Appendix 7: Robinson R22 and R44 ADs and SFAR 73	58
Appendix 8: Low-G effects (modified from CAA Vector article May/June 2015).....	62
Appendix 9: R44 flight manual limitations amendment (CAA).....	63
Appendix 10: Low-G mast-bumping and in-flight break-up sequence	68
Appendix 11: Robinson Safety Alert Low-G Mast Bumping Accidents.....	69
Appendix 12: Watchlist item.....	70
What is the problem?.....	70
What is the solution?	70
Background	70

Figures

- Figure 1 Robinson helicopter rotor head (source: AAIB)..... 6
- Figure 2 GPS positions and accident site 10
- Figure 3 Main rotor as found 11
- Figure 4 Main rotor driveshaft damage 12
- Figure 5 main rotor blade angles (source AAIB)..... 16
- Figure 6 Dissymmetry of lift due to forward airspeed (source: FAA) 17
- Figure 7 Tail rotor drift (source: FAA) 25
- Figure 8 Change of relative airflow in a downdraught (source: FAA) 26
- Figure 9 Teeter (flap)-pitch coupling (delta-three hinge) and contact between pitch link and pitch change horn..... 28
- Figure 10 Gyroscopic precession (source: FAA) 28
- Figure 11 contact between the pitch link and the pitch horn at the teeter limit (7.4 degrees) 29

Abbreviations

°T	degree(s) true
AAIB	Air Accidents Investigation Branch (United Kingdom)
AD	airworthiness directive
AGL	above ground level
BEA	Bureau d'Enquêtes et d'Analyses (France)
CAA	Civil Aviation Authority of New Zealand
Commission	Transport Accident Investigation Commission
CPL	commercial pilot licence
ELT	emergency locator transmitter
TAIC	Transport Accident Investigation Commission
FAA	Federal Aviation Administration (United States)
NTSB	National Transportation Safety Board (United States)
PPL	private pilot licence
R22	Robinson Helicopter Company helicopter model R22
R44	Robinson Helicopter Company helicopter model R44
R66	Robinson Helicopter Company helicopter model R66
Robinson	Robinson Helicopter Company
RPM	revolution(s) per minute
SFAR 73	Special Federal Aviation Regulation No. 73 (United States)

Glossary

angle of attack	the angle between the line of the chord of an aerofoil and the relative airflow
centre of gravity	the single point in a helicopter through which the weight (or force of gravity) acts
coning	(in the case of the Robinson main rotor blades) the vertical movement of a blade about a hinge axis perpendicular to the blade span
cyclic control	movement of the cyclic flight control causes the rotor blade pitch angles to change, which causes the rotor 'disc' to tilt in the same direction in which the pilot has moved the control. The helicopter then moves in that direction
cyclic pushover	the use of the cyclic control to push the nose of a helicopter down (over) in order to descend
collective lever	a flight control that changes the pitch angle of the main rotor blades simultaneously, and therefore the angle of attack and the amount of lift produced by the main rotor
dissymmetry of lift	the unequal production of lift across a rotor disc as a result of airspeed
gyroscopic precession	is when a force applied to a spinning gyroscope is transmitted 90 degrees in the direction of rotation i.e. pushing the front of a clockwise spinning disc down results in it tilting to the right.
knot	a speed of one nautical mile per hour, which equates to 1.85 kilometres per hour
low-G or reduced G	an acceleration less than that due to the force of gravity
mast	the main rotor driveshaft of a helicopter
mast-bump	contact between the inboard end of a main rotor blade (the spindle) and the main rotor driveshaft (or mast)
moderate turbulence	turbulence that causes: (1) changes in aircraft altitude or attitude; (2) variations in indicated airspeed; or (3) aircraft occupants to feel definite strain against seat belts
rotor disc	the area swept by the main rotor blades during each revolution
spindle	the inner end of a main rotor blade, which is attached to the rotor hub
teetering	the see-saw movement of a two-bladed, centrally mounted rotor hub, about a teeter hinge (or bolt)
teeter stops	urethane blocks fitted to a main rotor driveshaft that prevent the main rotor spindles contacting the driveshaft in normal operation, and allow +/- 7.4 degrees of teetering from the horizontal
type rating	the authorisation associated with a pilot's licence that states the pilot is qualified to fly a specific aircraft type (or model)

Data summary

Aircraft particulars

Aircraft registration:	ZK-HBQ
Type and serial number:	Robinson Helicopter Company R44 II, 10516
Number and type of engines:	one Lycoming IO-540-AE1A5, normally aspirated piston
Year of manufacture:	2004
Operator:	private
Type of flight:	ferry
Persons on board:	one
Pilot's licence:	private pilot licence
Pilot's age:	37
Pilot's total flying experience:	287 hours

Date and time 7 October 2014 at 0806¹

Location Kahurangi National Park
latitude: 41°12'18" south
longitude: 172°44'09" east

Injuries one fatal

Damage helicopter destroyed

¹ All times in this report are New Zealand Daylight Time (co-ordinated universal time + 13 hours) and expressed in the 24-hour format.

1. Executive summary

- 1.1. At about 0808 on 7 October 2014, a Robinson R44 helicopter (the helicopter) crashed into steep bush to the northeast of Mt Arthur, in the Kahurangi National Park. The helicopter was being flown from Karamea to Nelson for scheduled maintenance, through an area of forecast high winds and turbulence, at the time of the accident.
- 1.2. The helicopter broke up in flight after one of the main rotor blades struck the cabin and the main rotor assembly separated from the rest of the helicopter. The pilot, who was the only occupant, was killed.
- 1.3. The cause of the main rotor strike and subsequent separation was a phenomenon associated with helicopters having two-bladed, semi-rigid teetering main rotor systems, called ‘mast-bumping’:
 - Mast-bumping is where an excessive teetering or ‘see-saw’ movement of the main rotor causes the inner end (spindle) of the blades to contact the main rotor driveshaft (or mast), while rotating.
- 1.4. Mast-bumping can occur when a helicopter enters a low-gravity (low-G) condition (less than 1G to weightless/zero G), which can be caused by turbulence or induced by flight control inputs.
- 1.5. In-flight break-ups can also be caused by low main rotor revolutions per minute (RPM). However, the Transport Accident Investigation Commission (the Commission) determined that it was very unlikely that low main rotor RPM was a factor in this accident.
- 1.6. The Commission determined that it was very likely that the helicopter entered a low-G condition after crossing the Tasman Ranges downwind from Mt Arthur. Turbulence created by a strong southwest wind likely included severe downdraughts that prolonged the low-G condition, which likely initiated the mast-bumping.
- 1.7. The Commission could not rule out a flight control input as having contributed to the in-flight break-up.
- 1.8. The Commission made the following additional **findings**:
 - had a previous limitation on maximum wind speeds for inexperienced Robinson R44 pilots remained in place, as per that for Robinson R22 pilots, the pilot would have been prohibited from flying at the time of the accident, due to the forecast strong winds and turbulence
 - all Robinson helicopter models are susceptible to low-G mast-bumping, and any preventive measures should apply to all of them
 - due to their unique main rotor design, during a prolonged or severe low-G condition Robinson helicopters can roll rapidly to the right, and likely break up before a pilot can recover
 - a pilot’s instinctive reaction to an unexpected right roll, or the unintentional movement of a pilot’s limbs or upper body during severe turbulence or low-G, could lead to mast-bumping
 - although not an intuitive reaction to a sudden right roll, the aft cyclic technique is the only approved recovery technique, and should be used as soon as low-G is felt to ‘reload’ the main rotor disc and help reduce any right roll.
- 1.9. The Commission made the following **recommendation** to the Administrator of the Federal Aviation Administration:
 - extend the limitations and requirements of AD 95-26-04 that currently apply to the R22 in regard to operating in strong winds and turbulence, to the R44 and R66 models; and
 - extend those limitations and requirements to all R22, R44 and R66 pilots regardless of their experience levels.

1.10. The Commission made the following **recommendation** to the Director of Civil Aviation:

- until the FAA [Federal Aviation Administration] actions the above recommendation, he extend the limitations and requirements of AD 95-26-04 to R44 and R66 helicopters in New Zealand, and make them applicable to all pilots of Robinson helicopters in New Zealand regardless of their experience.

1.11. The **key lessons** identified from the inquiry into this occurrence are:

- pilots of two-bladed, semi-rigid rotor helicopters must be acutely aware of the risks and effects of encountering moderate or greater turbulence in strong winds, especially in the lee of high terrain
- if moderate or greater turbulence is encountered while flying a two-bladed, semi-rigid rotor helicopter, the pilot should consider landing and waiting for the conditions to improve
- pilots of two-bladed, semi-rigid rotor helicopters should be aware of the helicopters' increased susceptibility to low-G conditions when lightly loaded, and the adverse effects that high power and a high tail rotor have on the rate of roll
- pilots of Robinson helicopters should use the manufacturer's approved low-G recovery technique as soon as low-G conditions are felt.

2. Conduct of the inquiry

- 2.1. On Tuesday 7 October 2014 the Civil Aviation Authority of New Zealand (CAA) notified the Transport Accident Investigation Commission (the Commission) that the helicopter was missing and that a search was underway.
- 2.2. After an extensive ground and air search lasting four days, the accident site was located on 10 October 2014. The Commission subsequently opened an inquiry under section 13(1) of the Transport Accident Investigation Commission Act 1990.
- 2.3. On 11 October 2014 two Commission investigators began an inspection of the accident site. The wreckage was recovered on 13 October 2014 and was taken to the Commission's storage facility near Wellington.
- 2.4. The investigator in charge interviewed the owner of the helicopter and two other witnesses, who provided information about the weather in the area around the time of the accident. Records of the helicopter's maintenance history and the pilot's logbook were collected to review.
- 2.5. The helicopter was fitted with a TracPlus™ flight tracking system, which recorded automatic position reports from the helicopter. TracPlus Global Limited provided the investigation with the flight tracking data for the accident helicopter and the second helicopter flown by the owner.
- 2.6. The wreckage of the helicopter was reviewed in detail at the Commission's Wellington facility by the investigation team and a Robinson Helicopter Company (Robinson) safety investigator. A section of the main rotor blade was also inspected by a metallurgist.
- 2.7. A portable GPS (global positioning system) unit was recovered from the accident site and sent to the Australian Transport Safety Bureau in Canberra for recovery of the recorded data. The data recovered provided flight track information leading up to the accident.
- 2.8. The instructor who had carried out the pilot's Robinson safety awareness training and type ratings², and the flight examiner who had issued the pilot's helicopter licence, were both interviewed by the investigator in charge.
- 2.9. The CAA files on the pilot and the helicopter were reviewed. The pilot's personal and aviation medical history was reviewed.
- 2.10. On 6 October 2016 the Commission approved the circulation of the draft report to interested persons for comment.
- 2.11. The draft report was reviewed by an independent expert with experience in helicopter flight testing and certification.
- 2.12. Submissions were received from the manufacturer, the CAA, the owner and the pilot's next of kin. Any changes resulting from those submissions have been included in this final report.
- 2.13. On 22 February 2017 the Commission approved the publication of the final report.

² Type rating is the authorisation associated with a pilot's licence that states the pilot is qualified to fly a specific aircraft type (or model).

3. Factual information

3.1. Narrative

- 3.1.1. On 7 October 2014 a Robinson R44 II helicopter ZK-HBQ (the helicopter) was due at Nelson aerodrome for scheduled maintenance by 0815. The pilot ferrying³ the helicopter from its normal operating base at Karamea to Nelson had earlier checked the weather conditions along the proposed route and decided to delay his departure due to forecast high winds.
- 3.1.2. The pilot had met with the owner of the helicopter at Karamea aerodrome at about 0700 to discuss the forecast weather conditions. The pilot was concerned that winds of over 30 knots⁴ from the southwest were forecast for the area he was to fly through. The owner, who was about to depart in another R44 to work in the Kahurangi National Park, told the pilot he would assess the wind strength and contact him on the helicopter's radio.
- 3.1.3. The owner departed Karamea at 0709 and flew to Grange Ridge to pick up some Department of Conservation workers, before flying to Mt Owen. On the way to Mt Owen, at approximately 0730, the owner contacted the pilot by radio and reported that the wind strength was actually more like 15-20 knots and gusting at Grange Ridge. He suggested that the pilot fly up the Karamea River and then the Crow River, so that he would cross the Tasman Ranges to the south of Mt Arthur, which was clear of any cloud. After receiving this information the pilot decided to depart Karamea for Nelson.
- 3.1.4. Based on GPS⁵ and flight tracking data⁶ (see Appendix 1), the pilot departed Karamea aerodrome at about 0740 and flew up the Karamea River at about 500 feet above ground level (AGL). He then followed the Leslie River up to the Tablelands area to the west of Mt Arthur, before flying up the Flora Stream towards the Flora Saddle at about 500 feet AGL. That was a different route from that recommended to him by the owner. The pilot crossed over the Tasman Ranges to the northeast of Mt Arthur and approximately 500 metres to the southwest of the Flora Saddle at a height of about 350 feet AGL.
- 3.1.5. The final position report received from the TracPlus™ flight tracking system was:
- time: 0806 New Zealand Daylight Time
 - position: 041° 10' 29" south, 172° 42' 24" east
 - altitude: 3,990 feet (1,216 metres)
 - groundspeed: 83 knots
 - track: 108 degrees True (°T).
- 3.1.6. Based on the flight tracking data and information recovered from the on-board GPS unit, the time of the accident was about 0808.
- 3.1.7. At about 0840 the owner was back at Karamea preparing to fly the second R44 helicopter to Nelson for maintenance, with his wife and daughter on board. He viewed the position reports for the first helicopter on the flight tracking system before leaving, and saw that the pilot had flown up the Leslie River and crossed to the north of Mt Arthur, so he decided to follow him.
- 3.1.8. The owner flew along the same route the pilot had flown, and crossed the Tasman Ranges just to the north of the Flora Saddle. As he flew up the Flora Stream, about an hour after the pilot had done, he encountered moderate turbulence⁷ that "increased once [he] passed the Flora

³ A ferry or positioning flight is carried out to fly an aircraft to a location for maintenance or to start an operation from that location. It is not considered to be a flight for hire or reward.

⁴ A knot is a speed of one nautical mile per hour, which equates to 1.85 kilometres per hour.

⁵ The helicopter was fitted with a Global Positioning System (GPS) unit that displayed the current position and speed of the helicopter based on transmissions received from satellites.

⁶ The helicopter was fitted with a TracPlus™ GPS flight tracking system that transmitted position reports to a ground-based receiver every three minutes.

⁷ Moderate turbulence is turbulence that causes: (1) changes in aircraft altitude or attitude; (2) variations in indicated airspeed; or (3) aircraft occupants to feel definite strain against seat belts.

carpark". The Flora carpark at the end of the Graham Valley road was approximately one kilometre to the northeast of the point where the accident occurred.

- 3.1.9. The owner contacted Nelson Airport Control Tower⁸ after crossing the Tasman Ranges to ask whether the first helicopter had arrived at Nelson. The tower controller told him they had not heard from the pilot of the first helicopter, so the owner flew back to the last known point recorded by the flight tracking system to conduct a search. After searching the area around the Flora Saddle and listening for an emergency locator transmitter (ELT)⁹ transmission without success, the owner flew to Nelson and raised the alarm at the search and rescue hangar at the airport.
- 3.1.10. An extensive air search using the local rescue helicopter was subsequently carried out, focusing on the area around the last position recorded by the flight tracking system. Strong winds and turbulence were encountered by the pilots of the first search and rescue helicopters to reach the area. Several helicopters were used over the course of the next three days, and ground teams searched the dense bush in the area around the Flora Saddle. On the fourth day of searching the wreckage was found in steep, dense bush approximately 1.5 kilometres south of the Flora Saddle. The deceased pilot was found next to the wreckage, which had been destroyed by a post-impact fire.

3.2. Personnel information

- 3.2.1. The pilot had obtained a private pilot licence (PPL) (aeroplane) in February 2013, and then commenced helicopter flight training in September 2013 on the Robinson R22. Prior to his first solo flight in the R22 he had completed the required safety awareness training. He had obtained a PPL (helicopter) in November 2013.
- 3.2.2. The pilot had planned to complete a commercial pilot licence (CPL) (aeroplane) and a CPL (helicopter) after he had built up his hours to the required levels¹⁰ and after passing the theoretical exams in his spare time. He had built up his hours mainly flying aeroplanes between Karamea and Nelson and Karamea and Blenheim during the 18 months prior to the accident, and had only recently begun to build up his hours on helicopters. He had completed some of his exams and flight training for his CPL (aeroplane), and obtained a type rating for the R44 helicopter in September 2014.
- 3.2.3. The pilot had 287 hours' total flying time, consisting of 222 hours on aeroplanes and 65 hours on helicopters. At the time of the accident he had flown the R44 type for approximately 11 hours. The owner of the helicopter had offered the pilot work once he finished his CPL (helicopter) and the pilot had been carrying out ferry flights for the owner in the R44 to help build up his hours. As part of his PPL (helicopter) flight test in November 2013 his knowledge of the safety awareness training for the R22 had been assessed, and low-gravity (low-G¹¹) recovery techniques had been discussed.
- 3.2.4. In the 90 days prior to the accident flight the pilot had flown 20 hours on aeroplanes and 9.5 hours on helicopters (all on the R44). He had not flown in the seven days prior to the accident.
- 3.2.5. The pilot was reported to have been in good health on the morning of the accident.

3.3. Aircraft information

- 3.3.1. The Robinson Helicopter Company R44 is a four-seat light helicopter developed from the R22 two-seat model, and was introduced to service in 1993. The R44 II was first produced in 2002, and features a fuel-injected engine and a maximum certificated take-off weight of

⁸ Nelson Airport Control Tower is an air traffic control unit at Nelson aerodrome that controls the airspace in the Nelson aerodrome area.

⁹ An emergency locating transmitter (ELT) emits a distress signal during an accident that can be received by satellites and other aircraft.

¹⁰ A CPL (aeroplane) licence required 200 hours of flight time; a CPL (helicopter) licence required 150 hours of flight time.

¹¹ Low-g is an acceleration less than that due to the force of gravity.

1,134 kilograms. A turbine-powered, five-seat R66 completes the Robinson range of light helicopters, which are used worldwide for private and commercial flights.

- 3.3.2. The helicopter was manufactured in 2004 and had been operated by the owner since 2006. The airframe had accrued approximately 3,450 hours' total time and the engine had accrued approximately 2,146¹² hours since overhaul. At the time of the accident the helicopter had no outstanding defects and had a valid non-terminating airworthiness certificate.
- 3.3.3. The helicopter left Karamea with 85 litres of fuel on board, and the amount of fuel used during the 30-minute flight to the location of the accident was approximately 30 litres. The estimated weight of the helicopter at the time of the accident was 857 kilograms and the centre of gravity¹³ was 100.3 inches aft of datum. This was below the 1,034 kilograms maximum all-up weight limit and within the allowable centre of gravity range of 92 to 102.5 inches aft of datum.

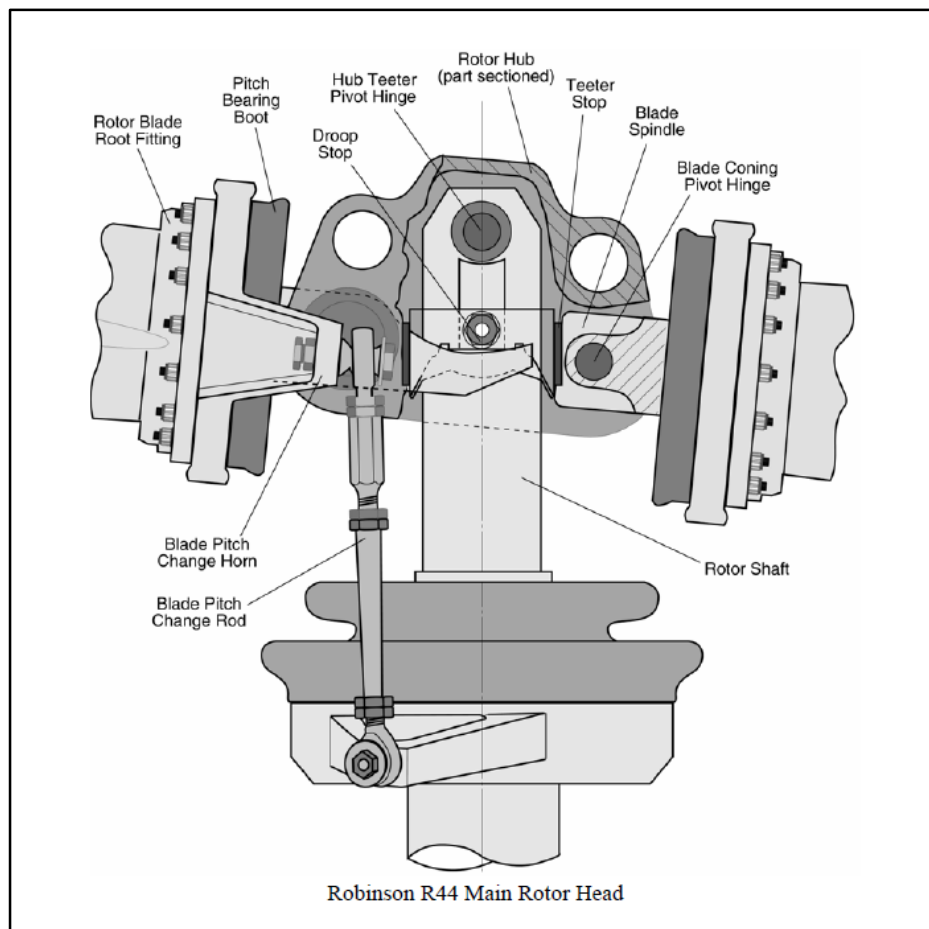

Figure 1
Robinson helicopter rotor head (source: AAIB)

Robinson helicopter main rotor system

- 3.3.4. All three Robinson types have two-bladed, semi-rigid teetering¹⁴ main rotors. The blades have independent coning¹⁵ hinges, a feature unique to Robinson (see Figure 1). Pilots flying helicopters with two-blade, teetering main rotor systems must avoid low-G¹⁶ conditions

¹² The normal time before overhaul of the engine was 2,000 hours; however, if the helicopter was flown on average more than 40 hours per month this could be extended to 2,200 hours.

¹³ The centre of gravity is the single point in a helicopter through which the weight (or force of gravity) acts.

¹⁴ Teetering is the see-saw movement of a two-bladed, centrally mounted rotor hub.

¹⁵ Coning is the vertical movement of a blade about a hinge perpendicular to the blade span.

¹⁶ Low-G conditions occur when an object is subjected to a net vertical force less than the force of gravity. When the vertical force is zero, the object is described as being 'weightless'.

because these can cause the helicopter to roll without the pilot making a control input (an uncommanded roll), which can lead to mast-bumping¹⁷.

- 3.3.5. The R44 flight manual included a limitation prohibiting low-G cyclic pushover manoeuvres, and contained the following information (Robinson, 21 February 2014, pp. 2-5):

Low-G cyclic pushovers prohibited.

CAUTION

A pushover (forward cyclic maneuver) performed from level flight or following a pull-up causes a low-G (near weightless) condition which can result in catastrophic loss of lateral control. To eliminate a low-G condition, immediately apply gentle aft cyclic. Should a right roll commence during a low-G condition, apply gentle aft cyclic to reload the rotor before applying lateral cyclic to stop roll.

- 3.3.6. The R44 main rotor controls, like those of the R22 and R66, are sensitive, and the following limitation appears in the flight manual (Robinson, 21 February 2014, p. 2.5):

CAUTION

Abrupt control inputs may produce high fatigue stresses and cause catastrophic failure of a critical component.

- 3.3.7. The Pilot's Operating Handbook comprised the mandatory Federal Aviation Administration (FAA) approved flight manual, as well as a section of 'Safety Tips and Notices' issued by the Robinson Helicopter Company. These safety tips and notices are applicable to all Robinson types. Several of the safety notices (see Appendix 6) provided guidance to pilots on how to avoid a potentially catastrophic "loss of control" of the main rotor. 'Loss of control' refers to the main rotor blades flying a path that might be different from that intended by the pilot, most commonly due to a low-G condition or because the rotor revolutions per minute (RPM) have decreased below the normal operating range.

3.4. Meteorological information

- 3.4.1. On 7 October 2014 the weather forecast (see Appendix 2) for the Tasman region was for areas of broken cloud to the west of the Tasman Ranges, with a base of 3,000 feet¹⁸ and cloud tops at 8,000 feet. A strong west-to-southwest flow was forecast to weaken late morning. The wind direction and speed at about the same altitude and at the time the pilot crossed the ranges were forecast to be from 260°T and 30-40 knots respectively.
- 3.4.2. At the time of departure the aerodrome forecast for Westport, the nearest¹⁹ aerodrome to Karamea, was for scattered cloud and 20 kilometres' visibility, with wind from 220°T and at 25 knots at an altitude of 2,000 feet. At the estimated time of arrival at Nelson, the weather was forecast to be scattered cloud and 30 kilometres' visibility, with wind from 220°T and at 35 knots at an altitude of 2,000 feet.
- 3.4.3. There was a SIGMET²⁰ issued for isolated severe turbulence in the upper South Island, north of a line between Westport and Christchurch. There was a risk to pilots of encountering severe turbulence when flying below 10,000 feet, at the time of the flight.
- 3.4.4. The owner said that the clouds in the Tasman Ranges were mainly to the northwest of Mt Arthur. He told the pilot that the area to the south of Mt Arthur was clear of cloud, and he

¹⁷ Mast-bumping happens when the inboard end of a main rotor blade (the spindle) contacts the main rotor driveshaft (or mast).

¹⁸ All altitudes, cloud bases and tops, and wind heights are expressed in thousands of feet above mean sea level (AMSL) unless specified. Cloud cover is expressed in eights or 'octas'; 'broken' cloud is five to seven octas of cover, scattered is three to four octas.

¹⁹ Westport aerodrome is 70 kilometres to the south of Karamea.

²⁰ A SIGMET is a forecast or report of significant weather that could present a danger to pilots in flight.

assessed the wind strength as being 15-20 knots and gusting at 4,000 feet, in the lower Karamea River area near Grange Ridge.

- 3.4.5. A hiker staying at Balloon Hut in the Tablelands area (about 10 kilometres to the west of Mt Arthur), on the night of 6 October 2014, recalled unsettled weather the following morning. She described scattered clouds early in the morning, followed by squally conditions and hail at about 0745. She recalled hearing a helicopter at around 0800, and that it was “very windy” at that time.
- 3.4.6. A landowner who lived approximately 10 kilometres to the east of the Flora Saddle recalled seeing “fog rolling in over the Flora Saddle” from the west, and a strong southwest wind early in the morning on the day of the accident.
- 3.4.7. The pilot of the first search and rescue helicopter to reach the accident site stated that the wind around the Flora Saddle had been about 20 knots when he arrived in the area. He had arrived at the site more than two and a half hours after the accident happened. That was about the time that the wind strength was forecast to reduce to 20 knots (see TN ARFOR in Appendix 2).

3.5. Flight recorders

- 3.5.1. There was no requirement for the helicopter to be fitted with a flight data recorder, and one was not fitted. However, the owner had installed a TracPlus™ flight tracking system that recorded flights (see Appendix 1) using GPS equipment and satellites, together with computer software that enabled the owner to view the helicopter’s location in flight. The on-board GPS equipment sent a position report every three minutes to satellites that transmitted the data to the computer program, to be stored for future reference or live viewing. Sometimes the transmissions from the on-board equipment would not be received by the satellites due to high terrain or aircraft structures blocking the signals to the satellites during turns, so a position report could be missed.
- 3.5.2. A portable GPS unit was also fitted for en-route navigation, which displayed a live map to the pilot and updated the helicopter’s position continually. The unit was found intact and the flightpath history was successfully recovered by the Australian Transport Safety Bureau. The unit had recorded the accident flight (see Figure 2) up to the point at which the break-up occurred and the power to the unit was interrupted. The route recorded on the portable GPS matched the one from the flight tracking system, but the GPS unit provided a more accurate and complete route as well as recording the final movement of the helicopter before it broke up.
- 3.5.3. The data from the on-board GPS showed that the pilot departed Karamea at 0743 and flew up the Karamea River, following it at low level to the junction with the Leslie River. The pilot then followed the Leslie River northeast to the Tablelands area before turning to the east to cross the Tasman Ranges to the south of the Flora Saddle, and to the northeast of Mt Arthur. The groundspeed of the helicopter was between 75 and 90 knots for the majority of the flight, with minor fluctuations above and below this range.
- 3.5.4. The pilot maintained an altitude of about 3,900 feet as he flew east up the Flora Stream towards the Flora Saddle, then turned slightly to the right to cross a ridgeline about 500 metres to the southwest of the Flora Saddle. He crossed the ridge at a height of about 350 feet AGL and five kilometres to the northeast of Mt Arthur. After crossing the ridge the helicopter started to turn further to the right and descend. The last recorded position on the GPS unit was 41°11’45” south and 172°44’11” east, with the helicopter in a turn to the right and descending through an altitude of about 3,700 feet.

3.6. Wreckage and accident site information

- 3.6.1. The main wreckage was found in dense bush on steep terrain approximately one kilometre south of the last position recorded on the GPS unit, at an altitude of about 2,200 feet (see Figure 2). The main wreckage, consisting of the cabin, engine, main rotor transmission and tail boom, fell through the tree canopy in a southerly direction. Despite being fitted with an

'impact-resistant' fuel tank, the cabin and fuselage had been burnt out by an intense fuel-fed fire as a result of the significant impact forces.

- 3.6.2. The first items found in the wreckage trail, which began approximately 500 metres from the last GPS position, included a rotor tie down, the aircraft flight manual and the GPS unit itself. These items were roughly in a line between the last GPS point and the main wreckage, with lightweight debris such as windscreen Perspex and paper documents found to the east of these items.

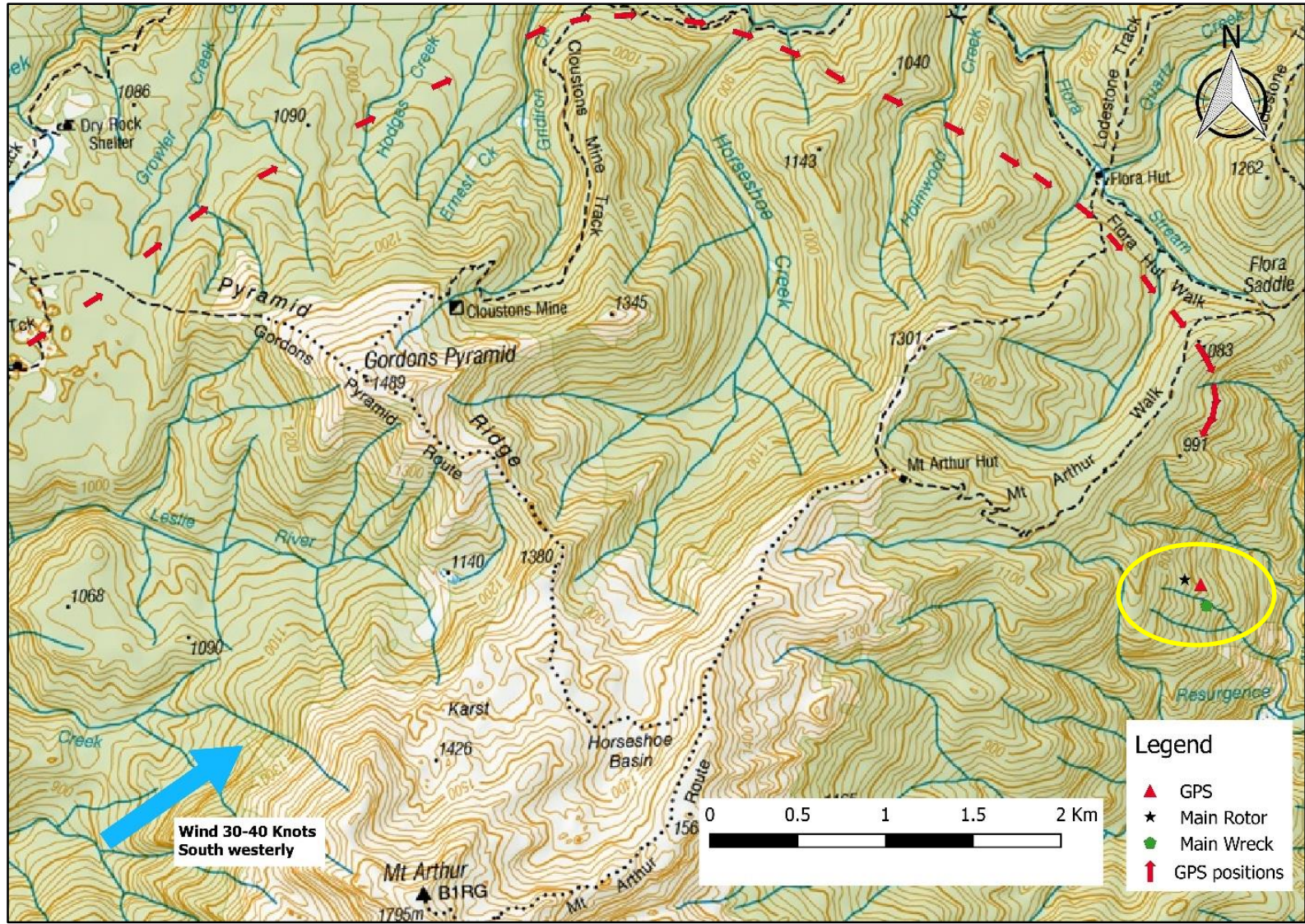

Figure 2
GPS positions and accident site



Figure 3
Main rotor as found

- 3.6.3. The main rotor was found approximately 100 metres from the main wreckage and to the west of the other items (see Figure 3). A three-foot outboard section of one blade was missing. The main rotor driveshaft had sheared just below the teeter stops²¹, which had been crushed by the blade spindles²² (see Figure 4). One of the pitch change horns had broken off, and both pitch change links had failed at the upper rod end threads. There was arc-shaped scoring damage to the main rotor hub outboard surfaces, and the remaining pitch change horn displayed impact damage.

²¹ Teeter stops are urethane blocks fitted to a main rotor driveshaft that prevent the main rotor spindles contacting the driveshaft in normal operation, and allow +/- 7.4 degrees of teetering from the horizontal.

²² A spindle is the inner end of a main rotor blade, which is attached to the rotor hub.

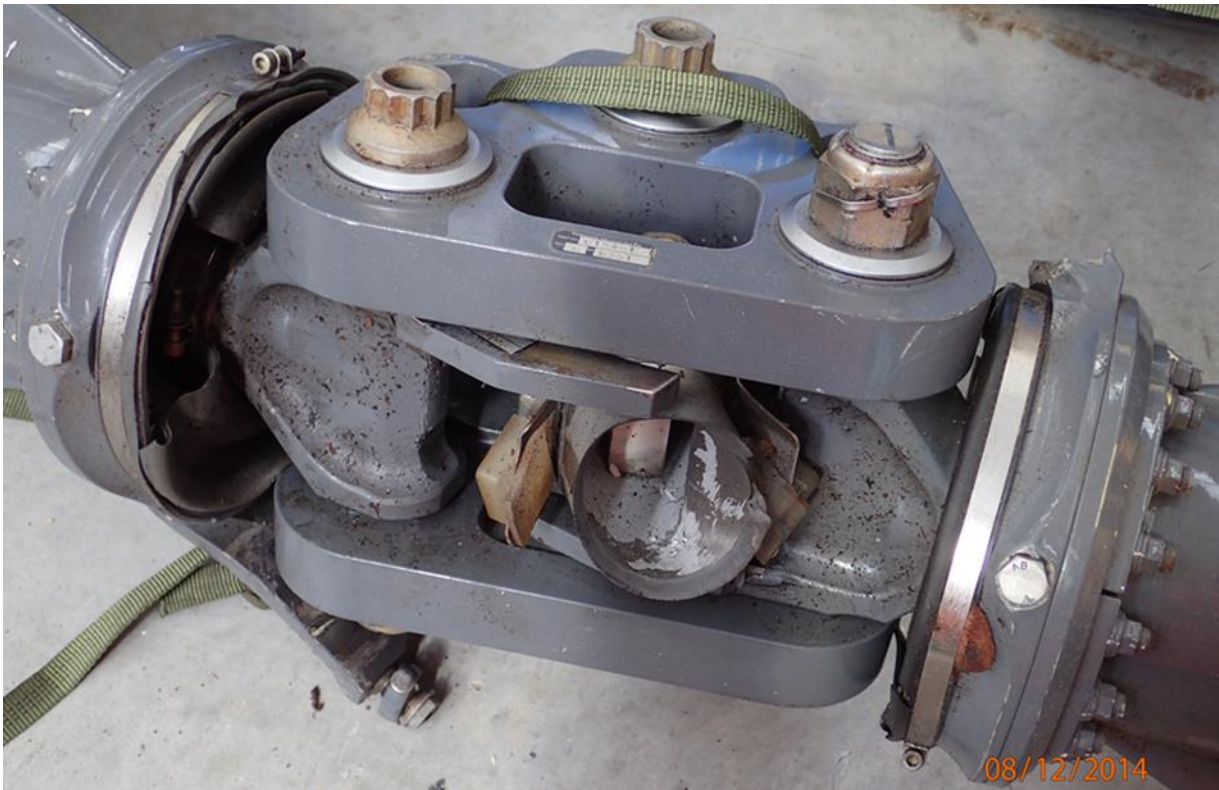

Figure 4
Main rotor driveshaft damage

3.6.4. The damage to the cabin and main rotor blades showed that one of the main rotor blades had entered the cabin and wrapped underneath the helicopter under rotation. The outboard section of this blade had then broken off when its leading edge struck the rear skid cross tube in an upward direction.

3.7. Medical and pathological information

3.7.1. A post-mortem examination determined that the pilot died from multiple injuries sustained during the accident.

3.7.2. The results of toxicology tests carried out indicated there were no performance-impairing substances present in the pilot's system.

3.8. Survival aspects

3.8.1. The search for the accident site took over three days because no signal was detected from the emergency locator transmitter (ELT)²³ and because the helicopter had crashed in dense bush and rugged terrain. It was later found that the co-axial antenna cable had separated from the ELT in the crash. The unit had been activated, but a signal would not have been transmitted effectively because of the separated antenna.

3.8.2. The position reports from the flight tracking unit fitted to the helicopter greatly reduced the size of the initial search area. Not all aircraft are fitted with tracking devices, and their effectiveness depends on the selected interval between position reports, the surrounding terrain, satellite positions and the installation of the units.

3.8.3. Although the accident was not survivable, the lack of an ELT signal delayed the discovery of the wreckage and the recovery of the pilot. More than 80 hours of helicopter flying were required to find the accident site, along with many hours of ground searching over three days.

²³ An ELT sends a primary signal on 406 megahertz for detection by search and rescue satellites. A lower-power, longer-duration secondary signal on 121.5 megahertz is to assist search aircraft to 'home in' on the site.

A more crashworthy ELT, or an ELT with an integral antenna, would have likely reduced the time required to find the site.

- 3.8.4. The Commission has previously made recommendations²⁴ regarding the use of flight tracking devices and improvements to the crashworthiness of ELTs. On 26 February 2014 the Commission recommended that the Director of Civil Aviation:
- a. encourage the use of flight tracking devices, especially for use in aircraft operating in remote areas around New Zealand (005/14)²⁵
 - b. continue to support the international work underway to improve the crash survivability of ELTs and to include GPS information in the data transmitted by such devices (006/14)²⁶.

3.9. Safety awareness training for pilots flying Robinson helicopters

- 3.9.1. The history of mast-bump accidents with the R22, and the actions taken to reduce their frequency, are pertinent to this investigation because all Robinson models have the same main rotor system design and similar responses to low-G. In 1996 the United States National Transportation Safety Board (NTSB) completed a special investigation into R22 mast-bump accidents²⁷. An overview of that investigation and the actions taken by the FAA in response is in Appendix 3.
- 3.9.2. During the NTSB investigation the FAA committed to establishing Flight Standardization Boards that would determine the operational and training requirements for pilots of future helicopters. The requirements were to include any additional knowledge or skills necessary for a typical pilot to handle the normal and emergency procedures applicable to a new type.
- 3.9.3. The first Flight Standardization Boards were established in February 1995 for the R22 and R44. The boards determined that it was necessary for R22 and R44 pilots to understand the effects of low-G and how to make a safe recovery from a low-G condition. Those topics are relevant for any helicopter with a two-bladed, teetering, underslung rotor system, but in 1995 they were not in the helicopter pilot licence training syllabus of the FAA (or the CAA). They have since been added to training syllabuses.
- 3.9.4. To formalise the boards' determinations, the FAA in March 1995 published Special Federal Aviation Regulation No. 73 (SFAR 73), which mandated "Special Training and Experience Requirements" for all pilots of R22 and R44 helicopters, including pilots who were already qualified to fly either type.
- 3.9.5. On 29 June 2009 the FAA concluded that SFAR 73 should be permanent for both the R22 and the R44, even though, by then, the pilot training syllabuses included the relevant topics. However, in New Zealand the requirement for R44 pilots to have the special training and experience had been deleted in 2004 as a result of a CAA flight manual amendment²⁸.
- 3.9.6. Between March 2014 and March 2015, the CAA conducted a review of SFAR 73 in the context of the New Zealand aviation system. This was in response to a recommendation made by the Commission during an inquiry into an R22 accident (see footnote 24). The review²⁹ conclusions included the following:

²⁴ Refer to Commission inquiry 11-003, in-flight break-up, ZK-HMU, Robinson R22, near Mt Aspiring, 27 April 2011.

²⁵ In September 2014 a consultation document was circulated by the CAA to seek feedback from the aviation industry regarding the required equipment for locating aircraft in an emergency.

²⁶ In December 2015 a Domestic Policy for the emergency location of aircraft was published by the CAA, which included a proposed revision of ELT standards and performance-based rules for ELTs.

²⁷ At the time, loss-of-main-rotor-control accidents accounted for more than a third of R22 accidents in the United States. During the special investigation the scope was widened to include similar R44 accidents.

²⁸ The training requirement was reinstated in May 2016; however, the experience requirements still apply to the R22 only.

²⁹ At the time of the CAA's review, New Zealand did not require SFAR 73 training for R44 pilots.

- d) ... as a result of the similarities of [the R22, R44 and R66] combined with New Zealand accident data it is important that R44 and R66 pilots have a clear understanding of [the topics covered in the Robinson special training] and mitigation strategies
- e) However ... there is currently no mechanism for requiring that those flying the R44 and R66 have had that training.

3.9.7. In April 2015 the CAA issued a consultation document, 'Robinson Helicopter Fleet', that described its proposals for regulatory change to:

- standardise the conduct and improve the oversight of the special Robinson training in New Zealand
- restore the special training requirement for R44 pilots (that had been removed in 2004³⁰)
- make the SFAR 73 special training applicable to R66 pilots.

3.9.8. Following public consultation on the proposed changes, the Director applied to the Wellington District Court in October 2015 for a Warrant of Authority to Impose Conditions on the operation of R22 and R44 helicopters. One of the operating conditions that the court granted reinstated SFAR 73 special training for New Zealand R44 pilots, with effect from 6 November 2015.

³⁰ The background to the removal of the requirement for R44 pilots was given in Commission report 11-003, in-flight break-up, ZK-HMU, Robinson R22, near Mt Aspiring, 27 April 2011.

4. Analysis

4.1 Introduction

- 4.1.1. This accident was the first confirmed in-flight break-up of an R44 in New Zealand, although there had been 13 in-flight break-up accidents in New Zealand involving the R22 model (see Appendix 5). An in-flight break-up of an R66 occurred in March 2013³¹, and another R44 in-flight break-up occurred in February 2015 (see footnote 42).
- 4.1.2. The conditions that can lead to in-flight break-ups are well known, and are commonly discussed during accident investigations and in safety information provided by manufacturers. The three main causal factors that can each lead to an in-flight break-up are:
- main rotor RPM below the normal operating range (low main rotor RPM)
 - abrupt or inappropriate cyclic control³² movements
 - low-G conditions resulting in mast-bumping.
- 4.1.3. In this accident the damage to the main rotor blades, teeter stops and blade spindles indicated that a mast-bump occurred prior to the in-flight break-up. Mast-bumping is when the main rotor teeters (or see-saws) beyond the normal operating limits and repeatedly contacts the teeter stops on the main rotor driveshaft (or 'mast'). In a severe case of mast-bumping the teeter stops are crushed, the mast itself is contacted, and an in-flight break-up occurs.
- 4.1.4. It is difficult to determine the exact sequence of events that lead to severe mast-bumping and in-flight break-ups, as they are always fatal and happen extremely quickly. The level of destruction and the historical lack of witnesses or any recording devices on light helicopters make the task of analysing break-ups difficult.
- 4.1.5. There had been two recent non-fatal mast-bumping incidents involving R22s in New Zealand, of which one was investigated by the Commission³³. These incidents have helped the understanding of what happens during mast-bumping, and in particular the conditions that lead to it developing and the pilot's successful recovery of the situation.
- 4.1.6. The following sections discuss what likely happened leading up to the in-flight break-up, the three main causal factors, and the Robinson main rotor system design and dynamic behaviour in low-G conditions. Low-G in turbulence, pilot training requirements and operating limitations for Robinson helicopters are also discussed, as are aerodynamic and design factors that could contribute to low-G mast-bumping, and low-G recovery techniques.

4.2. What happened

- 4.2.1. The damage to the cabin, rear skid cross tube and one of the main rotor blades showed that the main rotor blade struck the cabin and initiated the in-flight break-up. The pitch change links that controlled the angle of the main rotor blades failed³⁴, which likely happened after the teeter stops had been crushed and prior to the break-up. When both pitch change links fail in flight, the main rotor blades can rotate uncontrolled around their spindles, which changes their pitch angles (see Figure 5). Depending on a number of variables, including aerodynamic loads and flight control inputs at the time of failure, the main rotor blades can go into either a positive or a negative angle of attack (see Figure 5), causing them to fly up or down.

³¹ Refer Commission inquiry AO-2013-003, Robinson R66 ZK-IHU, mast bump and in-flight break-up, Kaweka Range, 9 March 2013.

³² The movement of the cyclic flight control causes the rotor blade pitch angles to change, which causes the rotor 'disc' to tilt in the same direction in which the pilot has moved the control. The helicopter then moves in that direction.

³³ Refer Commission inquiry AO-2013-005, Robinson R22 ZK-HIE, in-flight loss of control, New Plymouth, 30 March 2013.

³⁴ The pitch change links can fail in compression or tension as a result of reverse cycle bending during extreme teetering of the main rotor system outside the normal operating limits, due to contact with the pitch change horn.

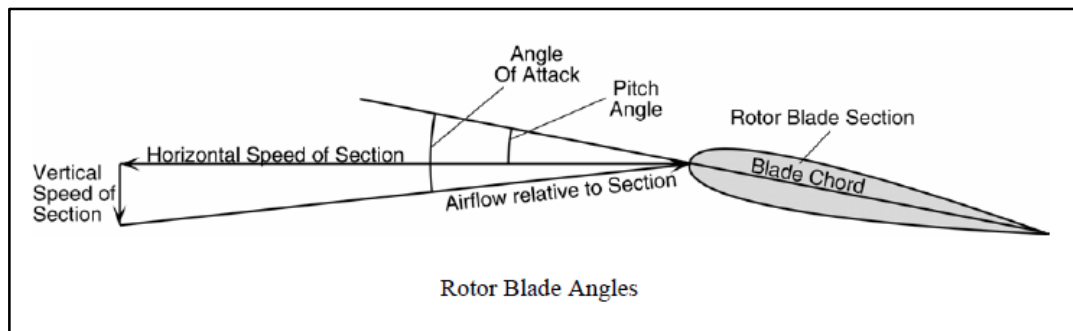

Figure 5
Main rotor blade angles (source: AAIB)

- 4.2.2. One of the main rotor blades was bent in an upward direction, with creases in the upper surface of the blade. This could have been caused by excessive coning of the blade in a low-rotor-RPM situation, where the lift produced and the centrifugal forces on the blade would have been overcome by the weight of the helicopter, and the blade bent up towards the tips. It could also have been caused by an uncontrolled blade going into a very high angle of attack³⁵, with the subsequent high aerodynamic drag loads resulting in bending in an upwards and rearwards direction opposite to the direction of rotation.
- 4.2.3. The other main rotor blade had bent in a downwards direction and entered the cabin, before folding underneath the helicopter and striking the rear skid cross tube, which broke off the outboard three-foot section of the blade. It is likely that this happened as a result of the failure of the blade's pitch change link and the blade's subsequent rotation into a negative angle of attack. If the blade had gone into a negative angle of attack, instead of producing lift in the normal upward direction, a downward aerodynamic reaction would have forced the blade into the cabin. This is a form of main rotor 'divergence'³⁶, where the main rotor disc³⁷ goes in an undesired or uncommanded direction, and is typical of a low-G-induced mast-bump (see Appendix 10).
- 4.2.4. Once the blade entered the cabin and struck the rear skid cross tube, a sudden overload of the main rotor drive system occurred. The bending and torsional failure of the thick steel main rotor driveshaft likely happened at this point, and indicates that a significant amount of power was being delivered by the engine at the time. The main rotor then separated from the helicopter and the fuselage fell to the ground.

Finding

1. A mast-bump occurred, which led to rotor divergence and the in-flight break-up.

In-flight break-up causal factors

4.3. Low main rotor RPM

- 4.3.1. If the main rotor RPM is allowed to reduce below the normal operating range, main rotor stall and an in-flight break-up can result (see Appendix 6, safety notice 10). A reduction in RPM can be caused by overpitching³⁸ the blades to the point where the engine can no longer maintain rotor RPM, or by not reducing the angle of attack of the blades quickly enough after an engine failure. A main rotor divergence caused by low rotor RPM is different from that caused by low-G mast-bumping, with the rearward travelling blade normally moving in a

³⁵ Damage seen on blades and rotor hub outboard surfaces show the blades can rotate 90 degrees or more, which could result in the blades being perpendicular to the airflow.

³⁶ A main rotor divergence refers to a main rotor disc tilting or moving in an undesired or uncommanded direction.

³⁷ The main rotor disc is the area or space taken up by the blades in one revolution.

³⁸ Overpitching is where the pilot increases the angle of attack of the main rotor blades to the point where the aerodynamic drag on the blades cannot be overcome by the engine and the main rotor RPM decreases.

downward direction. In most low-G mast-bump in-flight break-ups, the forward travelling blade moves in a downward direction.

- 4.3.2. The speed of a helicopter in forward flight creates a dissymmetry of lift³⁹ across the rotor disc due to the higher speed through the air⁴⁰ of the forward travelling blade compared with the rearward travelling blade (see Figure 6). The unequal lift produced by the rotor disc is normally compensated for by reducing the effective angle of attack of the forward-travelling blade by teetering (flapping) the rotor blade up with each revolution, and the opposite rearward-travelling blade down to increase its effective angle of attack (see Appendix 4). If the main rotor RPM reduces below the normal operating range, the speed of the rearward travelling blade through the air can fall below that required to maintain the airflow over the upper surface of the blade. The blade will then experience an aerodynamic stall and lose lift.

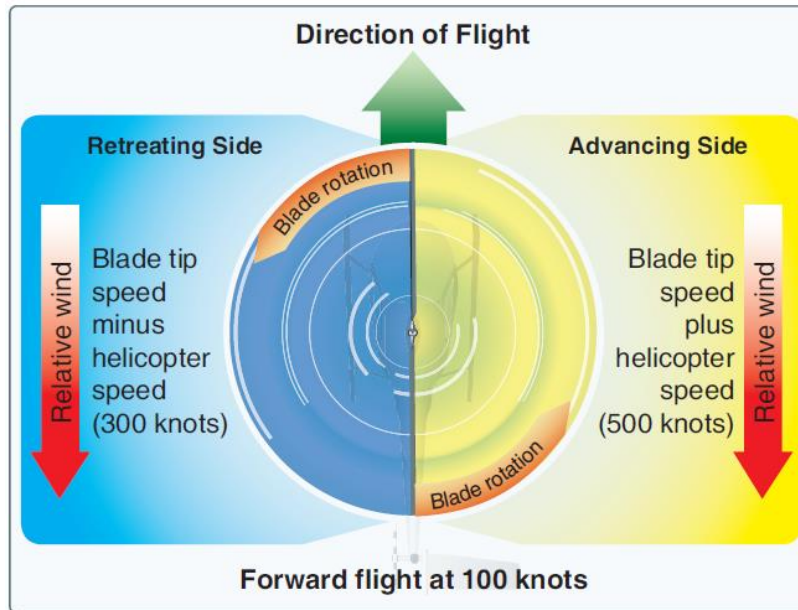

Figure 6
Dissymmetry of lift due to forward airspeed (source: FAA)

- 4.3.3. In this situation the forward travelling blade with its higher speed through the air has not stalled and is still producing lift, so the net effect is that the rearward travelling blade 'wants' to dive and the forward travelling blade 'wants' to climb. Due to gyroscopic precession⁴¹ (see Appendix 4), the result of this type of divergence is that the rotor disc tilts rearwards and the rotor blades strike or sever the tail boom.
- 4.3.4. In both of these cases of rotor divergence the teeter stops are crushed; the main difference is whether the cabin or the tail boom is struck by the blades. In this accident the tail boom of the helicopter was not struck by the main rotor and the forward travelling blade moved downward and entered the cabin.

Finding

2. The in-flight break-up was very unlikely to have been caused by low main rotor RPM (revolutions per minute).

³⁹ Dissymmetry of lift is the unequal production of lift across the rotor disc as a result of forward airspeed.

⁴⁰ Airspeed refers to the speed of an aircraft; the speed of a rotor through the air is the helicopter's airspeed plus the speed or rotation (RPM) for the forward travelling blade, or minus for the rearward travelling blade.

⁴¹ Gyroscopic precession is when a force applied to a spinning gyroscope is transmitted 90 degrees in the direction of rotation i.e. pushing the front of a clockwise spinning disc down results in it tilting to the right.

4.4. Abrupt, inappropriate or inadvertent cyclic control movement

- 4.4.1. The flight controls of all Robinson helicopter models are very sensitive. Small movements of the cyclic control are required to avoid over-controlling and producing high stresses on critical control components, which can cause catastrophic failures (see 3.3.6).
- 4.4.2. Many in-flight break-up accident reports have concluded that due to the absence of mechanical failures, the causal factor was likely an inappropriate cyclic control input from the pilot that led to mast-bumping. However, it is impossible to determine if a pilot had made an inappropriate cyclic control input without a flight data recorder on board that records the pilot's inputs leading up to the break-up. In response to a number of unexplained fatal accidents involving Robinson helicopters, the Commission has made a recommendation to the Ministry of Transport that it promote the installation of lightweight flight data or video recorders⁴² in small helicopters, in an effort to collect data that would help to determine the causes of similar accidents.
- 4.4.3. A common factor identified in some early mast-bumping and in-flight break-up accidents was that the pilots were relatively inexperienced on helicopters and had more experience flying aeroplanes (see Appendix 6, safety notice 29). However, in New Zealand, recent mast-bumping accidents⁴³ have involved pilots with significant experience on Robinson helicopters and very little experience on aeroplanes, which suggests that other factors are involved.
- 4.4.4. Certain flight control inputs used by pilots in aeroplanes, such as pushing forward on a control column to descend, can become automatic over time. Such control inputs can produce a low-G or weightless⁴⁴ condition felt by the occupants as strain against their seat belts, which is generally safe in an aeroplane. However, these habits should not be transferred and used in helicopters, as the low-G condition can lead to mast-bumping in a two-bladed, semi-rigid, teetering rotor system. The pilot of a Robinson helicopter must make gentle movements of the cyclic control and use the collective lever⁴⁵ to descend to avoid inducing an inadvertent low-G condition or aggravating it in turbulent conditions.
- 4.4.5. The pilot did not have a lot of experience on Robinson helicopters, but he had completed safety awareness training for the R22. He should have been aware of the risk of applying an inappropriate cyclic control input and was unlikely to have done this intentionally. However, if a pilot were suddenly surprised by something, such as an impending collision with a bird or another aircraft, or if a helicopter suddenly rolled or pitched to an extreme angle, a natural or instinctual reaction could result in an abrupt control input to avoid a conflict or correct an unusual attitude.
- 4.4.6. Pilots must also try to prevent inadvertent cyclic inputs during severe turbulence when unrestrained arms and legs can move the cyclic control, which would be particularly difficult in a near-weightless condition or right roll during a low-G encounter. A lightly loaded helicopter would also be more susceptible to being 'bounced' around in turbulence.
- 4.4.7. The pilot was relatively inexperienced on helicopters, but had flown Robinson helicopters exclusively, and learnt to fly in the mountains of the South Island where turbulence is common. Although he had more experience flying aeroplanes than helicopters, he was also relatively inexperienced in flying aeroplanes. It was not possible to establish whether the pilot made a control input that contributed to the in-flight break-up, and it could not be excluded as a potential factor.

⁴² Refer to Commission inquiry AO-2015-002 R44 ZK-IPY, in-flight break-up, Lochy River, 19 February 2015.

⁴³ Refer to Commission inquiries 08-007 Robinson R22 ZK-HXR, loss of control, Lake Wanaka, 1 November 2008 and 11-003, in-flight break-up ZK-HMU, Robinson R22, near Mt Aspiring, 27 April 2011.

⁴⁴ A low-G condition occurs when an object is subjected to a net vertical force less than the force of gravity. When the vertical force is zero, the object is described as being 'weightless'.

⁴⁵ The collective lever changes the angle of attack of all main rotor blades simultaneously, thus changing the amount of lift produced by the main rotor making the helicopter climb or descend.

Finding

3. An abrupt, inappropriate or inadvertent cyclic control input by the pilot could not be ruled out as having contributed to the in-flight break-up.

4.5. Low-G in turbulence

4.5.1. The weather forecast for the Tasman area at the time of the flight, and the report given by the owner in the second helicopter, suggested that the pilot would have experienced moderate turbulence along the route flown, particularly around the Flora Saddle area. It was also likely that he encountered patches of isolated severe turbulence, which had been predicted in the SIGMET warning issued for the time of the flight.

4.5.2. Robinson had first issued a safety notice in regard to flying in strong winds or turbulence in 1998 (see Appendix 6, safety notice 32), which recommended in part:

Flying in high winds or turbulence should be avoided [this sentence was added in February 2016]

1. *Reduce power and use a slower than normal cruise speed. Mast bumping is less likely at lower airspeeds.*
2. *For significant turbulence, reduce airspeed to 60-70 knots.*
3. *Tighten seat belt and rest right forearm on right leg to minimise unintentional control inputs.*
4. *Do not overcontrol. Allow aircraft to go with turbulence, then restore level flight with smooth, gentle control inputs.*
5. *Avoid flying on the downwind side of hills, ridges, or tall buildings where turbulence will likely be most severe.*

4.5.3. The R44 flight manual contained the following caution in the 'Normal Procedures: Cruise' section:

CAUTION

If turbulence is expected, reduce power and use a slower than normal cruise speed

4.5.4. The flight tracking information and the data recovered from the on-board GPS unit showed that the pilot was flying at 70-90 knots groundspeed for most of the flight. Allowing for a 10-20 knot tailwind based on the forecast wind speed and direction, the pilot would have kept to an airspeed of 60-70 knots for most of the flight. This suggested that he slowed down as per the safety notice and the caution in the flight manual, very likely due to experiencing significant turbulence during the flight.

4.5.5. As the pilot flew up the Flora Stream towards the Flora Saddle his groundspeed was about 83 knots, and as the forecast wind was a direct crosswind from right to left at this point, this would have also been close to his airspeed. Shortly after crossing the ridge to the south of the Flora Saddle, the helicopter turned to the right towards the downwind side of Mt Arthur and started to slow down and descend. The helicopter then flew towards the more turbulent air in the lee of Mt Arthur and increased its descent once it was northeast of the summit. The wind was coming from the opposite direction, the southwest. The turn to the right may have been made to avoid cloud in the Flora Saddle area, and the start of the descent could have been intentional in order to descend over the lower terrain in the Pearce River valley to find smoother air beneath. The increase in descent could also have been due to a downdraught produced by the disturbed airflow over Mt Arthur.

4.5.6. Turbulence, updraughts and downdraughts are present in mountainous areas when there are strong winds above about 15 knots. The severity and amount of turbulence depend on the height and shape of the land and the direction from which the wind is coming. Steep ridges

and mountains with long and sharp peaks, together with a strong wind at a perpendicular angle to the terrain, produce the worst turbulence conditions. Updraughts are created on the upwind side of mountains and valleys, which are relatively smooth, and increase the G-loading⁴⁶ on an aircraft when first encountered. Downdraughts and turbulence are created on the downwind or lee side of mountains and valleys, producing unstable 'rough' air, and reduce the G-loading on an aircraft when first encountered.

- 4.5.7. With the forecast wind of 30-40 knots from the southwest there would have been moderate to severe turbulence in the lee of and below the height of Mt Arthur, extending to the northeast of its summit and below 6,000 feet above mean sea level. The helicopter increased its descent then broke up to the northeast of Mt Arthur at an altitude of about 3,800 feet. The owner (who was flying the second, heavier helicopter) experienced moderate turbulence at about the same altitude over the Flora carpark, which increased after passing the Saddle. The Flora carpark was also to the northeast of Mt Arthur, but further away from it and on the windward side of a ridgeline. It was very likely that the pilot experienced moderate to severe turbulence as he crossed the ridge to the south of the Flora Saddle, and he likely encountered a severe downdraught in the lee of Mt Arthur and the ridgeline he had just crossed.
- 4.5.8. Moderate turbulence can produce G-loading fluctuations of +/- 0.5-1.0G, while in severe turbulence the fluctuations can be greater than +/- 1.0G⁴⁷. Turbulence is normally in isolated patches, however, and encountered momentarily as the aircraft flies through it into 'clean' air. Severe downdraughts can initially produce a reduction of up to 1G, providing a weightless condition of zero G. Downdraughts can also last longer than turbulence, so a reduced or low-G condition could persist. The pilot likely encountered a severe downdraught, which would have likely reduced the G-loading on the helicopter (by 0.5G to 1G) to a near weightless condition, over a period of several seconds.

Findings

4. The actual wind and turbulence at the time of the accident were very likely to have been the same as, or stronger than, the forecast conditions.
5. The helicopter very likely encountered moderate to severe turbulence and an associated severe downdraught in the lee of Mt Arthur, which likely created a prolonged low-G condition.

History of low-G mast-bumping

- 4.5.9. Mast-bumping was first discovered in the 1960s as the result of a number of unexplained accidents that occurred whilst pilots were training for, and in action during, the Vietnam war. The United States Army was losing helicopters on a regular basis while they were being flown at low levels over undulating terrain. The types of helicopter involved were the Bell UH-1 'Iroquois' and Bell AH-1 'Cobra', which both had two-bladed, semi-rigid teetering main rotors. It was determined that the in-flight break-ups of these helicopters were caused by low-G mast-bumping that had been induced by the pilots' flying techniques.
- 4.5.10. Other helicopter types in use at the time, including the Hughes OH-6⁴⁸, had rigid rotor heads and were not susceptible to low-G mast-bumping as they did not teeter. Pilots of these helicopters flew them in a similar way to aeroplanes when flying over and following low terrain in that they pushed forward on the cyclic controls to descend over ridges and hills. When pilots of Bell helicopters did this aggressively, the subsequent low-G conditions sometimes led to mast-bumping and catastrophic failure of the rotor systems. A technique involving the use

⁴⁶ G-force is the force of gravity or weight acting on an object. When stationary or in balanced flight an aircraft experiences 1G; so does a human being standing still.

⁴⁷ Refer International Civil Aviation Organization and World Meteorological Office turbulence code table and categories.

⁴⁸ The Hughes OH-6 was later developed into a civilian variant called the Hughes 500, which is commonly used in New Zealand, particularly around mountainous terrain because it handles turbulence well.

of the collective lever to climb and descend over undulating terrain was introduced for the Bell types to avoid low-G conditions, and mast-bumping accidents were almost eliminated.

- 4.5.11. Bell Helicopter made a commercial variant of the UH-1, designated the B205. It also developed a smaller civilian utility helicopter called the B206 'JetRanger'⁴⁹, which used a two-bladed, semi-rigid main rotor system similar to the ones on the UH-1 and B205. Neither the B205 nor the B206 had issues with low-G mast-bumping in service, and the problems with the military models were put down to aggressive flying at low levels and cyclic pushovers that led to the in-flight break-ups.
- 4.5.12. There were relatively few cases of in-flight break-up caused by low-G mast-bumping in the 1970s, even though there were a number of helicopters in civilian use with two-bladed, semi-rigid teetering rotors. These were mostly the Bell helicopter series, including the older Bell 47⁵⁰ and the Hiller UH-12 helicopters⁵¹.

Robinson helicopters

- 4.5.13. In the early 1980s the Robinson R22 entered service and was frequently used as a training or private aircraft due to its lower operating costs. A number of unexplained in-flight break-up accidents started to occur throughout the 1980s and into the early 1990s.
- 4.5.14. The majority of these accidents involved the R22 helicopter, and this prompted the FAA to carry out a special review of the R22 certification process in the early 1980s and again in the early 1990s. A main rotor flapping survey was carried out by the manufacturer in 1982 for the R22, and in 1995 for the R44. After reviewing the survey results the FAA found that the R22 and R44 were safe "when flown within its operating limitations", and Robinson subsequently added a limitation in the flight manual that prohibited cyclic pushovers.
- 4.5.15. Concerned with the number of 'loss of rotor control' accidents involving the R22, the NTSB opened an investigation into the certification and flight characteristics of the R22 and R44 in 1994 (see Appendix 3). The NTSB subsequently recommended to the FAA that it introduce special training for pilots of Robinson helicopters and impose limitations on their operation until a study was carried out into the causes of the loss of rotor control and the dynamic behaviour of the Robinson rotor system. The study was partially completed but ended due to lack of funds. Crucially, the dynamic behaviour of the Robinson rotor system during low-G mast-bumping was not fully explored.
- 4.5.16. The R22 flight manual contains the following message as required by FAA AD 95-26-04:

Until the FAA completes its research into the conditions and aircraft characteristics that lead to main rotor blade/fuselage contact accidents, and corrective type design changes and operating limitations are identified, Model R22 pilots are strongly urged to become familiar with the following information and comply with these recommended procedures:

Mast Bumping: Mast bumping may occur with a teetering rotor system when excessive main rotor flapping results from low "G" (load factor below 1.0) or abrupt control input. A low "G" flight condition can result from an abrupt cyclic pushover in forward flight. High forward airspeed, turbulence, and excessive sideslip can accentuate the adverse effects of these control movements. The excessive flapping results in the main rotor hub assembly striking the main rotor mast with subsequent main rotor system

⁴⁹ The B206 'JetRanger' has been used in New Zealand since the late 1970s in a number of roles including search and rescue, agricultural spraying, scenic flights, firefighting and training.

⁵⁰ The Bell 47 was a two-seat training and utility helicopter first flown in 1945 and used in New Zealand since the early 1960s by the Royal New Zealand Air Force for training, and in the civilian sector for deer recovery and commercial work in the mountains.

⁵¹ The Hiller UH-12 has been used in New Zealand since the late 1950s for commercial work, and was also used in the mountains for deer capture and recovery.

separation from the helicopter.

To avoid these conditions, pilots are strongly urged to follow these recommendations:

- 1) Maintain cruise airspeeds between 60 [knots] and less than 0.9 Vne, but no lower than 57 [knots]...
- 2) Avoid large, rapid forward cyclic inputs in forward flight, and abrupt control inputs in turbulence.

4.5.17. The FAA issued Airworthiness Directives for both the R22 and R44 (see Appendix 7) in 1995 that mandated special awareness training⁵² for both types. The training included the subject of low-G mast-bumping, and minimum levels of experience were introduced before a pilot could manipulate the flight controls or fly solo. The following limitations were incorporated into the flight manuals of the R22 and R44, and applied to pilots with less than 200 hours on helicopters or less than 50 hours on Robinson helicopters:

1. Flight when surface winds exceed 25 knots, including gusts, is prohibited.
2. Flight when surface wind gust spreads exceed 15 knots is prohibited.
3. Continued flight in moderate, severe, or extreme turbulence is prohibited.

The following flight manual limitation applied to all pilots of R22 and R44 helicopters:

Adjust forward airspeed to between 60 knots indicated airspeed (KIAS) and 0.7 Vne but no lower than 57 KIAS, upon inadvertently encountering moderate, severe, or extreme turbulence

4.5.18. The flight manual limitations were later removed from the R44 as it was deemed to be a more stable design than the R22. The decision was based on the accident rates of the R44, which were not as high as the R22, and the fact that the R44 had not had the same issues with main rotor loss of control that affected the R22. However, the special awareness training requirement remained for the R44 in the United States, and in 2009 the FAA made it permanent for both the R22 and the R44⁵³.

New Zealand situation

4.5.19. In New Zealand the CAA adopted the limitations and special awareness training requirements for the R22 and R44, although it called it safety awareness training and made some minor changes to the wording (see Appendix 7). The CAA changed the wording of the wind speed limitation to remove the word 'surface', which meant that any wind above 25 knots would prohibit flying for a pilot with less than the minimum flight experience of 200 hours on helicopters or 50 hours on type. The CAA initially applied the limitations to the R44 as well, but then followed the FAA by removing the limitations from the R44 in 2004. The CAA also removed the safety awareness training requirement for the R44 at the same time.

4.5.20. Had those limitations still applied to the R44 at the time of the accident, the pilot would have been prohibited from carrying out the flight as he had less than 200 hours on helicopters and because the wind speed was over 25 knots. He would have also been prohibited from continuing the flight if he had encountered moderate turbulence. If he had been flying an R22 the flight would have been prohibited, as those limitations still applied to that model.

⁵² Special Federal Aviation Regulation (SFAR) No. 73, issued on 27 February 1995.

⁵³ The FAA decided not to extend the special awareness training to the R66 when it was certified in 2010.

Finding

6. Had a previous limitation on maximum wind speeds for inexperienced R44 pilots remained in place, as per that for R22 pilots, the pilot would have been prohibited from flying at the time of the accident due to the forecast strong winds and turbulence.

- 4.5.21. The rate of low-G mast-bumping accidents in New Zealand has increased since the early 1990s, and in the period 2012-2015 there were six low-G mast-bumping occurrences (see Appendix 5). There have been no reported accidents in New Zealand that occurred as a result of low-G, involving a type of helicopter other than the Robinson. There are nearly 900 helicopters flying in New Zealand, with Robinson models making up over a third of this number. Two bladed, semi-rigid teetering rotor helicopters, including Bell models, account for over half of all helicopters in New Zealand⁵⁴. According to the CAA's database of helicopter accidents, the rate of loss-of-control accidents, which include mast-bumping, has increased since the year 2000, while rates for most of the other categories have stayed the same or reduced. The number of Robinson helicopters in New Zealand has tripled in the same period.
- 4.5.22. In response to the increased rate of mast-bumping, and two recommendations made by the Commission in 2014⁵⁵, the CAA in 2015 reviewed the content and delivery of the safety awareness training for the R22 in New Zealand and how the requirements issued by the FAA were being implemented. The result of the review was that training standards and experience requirements were brought in to line with those in the United States, and the R44 was included in the safety awareness training. The wind limitations remained unchanged and still only apply to the R22. In the consultation document for the proposed changes, the R66 was to be included in the safety awareness training, but after the submission process the CAA decided not to include the R66.
- 4.5.23. As a result of the increase in the rate of low-G mast-bumping accidents involving Robinson helicopters, the Commission decided to add this issue to its 'Watchlist'⁵⁶ in August 2016. Low-G mast-bumping accidents involving Robinson helicopters will be closely monitored in New Zealand to help identify all of the factors contributing to this problem.

R44 and R66 Models

- 4.5.24. There have been several recent in-flight break-up accidents involving R44 and R66 types in the United States, Asia and Europe. An accident in France that occurred on 3 September 2012 involved an R44 with two people on board that broke up in flight while flying over mountainous terrain in high winds. The accident report included a Safety Recommendation to amend the flight manuals of the R22 and R44 to include information relating to flight in turbulence in the 'Limitations' section⁵⁷.
- 4.5.25. All three Robinson types share the same basic rotor design and flight control components, and are subject to the same dynamic forces. The higher overall rate of R22 accidents can in part be explained by their use as training helicopters and the level of experience of their pilots. However, all three types have now been involved in low-G mast-bumping accidents⁵⁸, and the same risk of encountering low-G conditions in turbulence applies to all of them.
- 4.5.26. With a lower rotor loading and less inertia, small helicopters like the R22 are more prone to low-G conditions in turbulence. Larger helicopters such as the R44 and R66 are also

⁵⁴ Refer New Zealand Helicopter Association safety bulletin issue 4, 2014.

⁵⁵ Refer Commission inquiry 11-003, Safety Recommendations 14/003 and 14/004.

⁵⁶ The Watchlist highlights the most pressing of the Commission's concerns with respect to safety across the three transport modes that fall within its mandate. Refer to www.taic.org.nz.

⁵⁷ Refer BEA accident report ec-t120903 April 2016 and Recommendation 2015-030. https://www.bea.aero/uploads/tx_elydrappports/ec-t120903.en.pdf

⁵⁸ Refer to Commission inquiries AO-11-003, AO-2013-003, and AO-2015-002.

susceptible to turbulence when lightly loaded, as was the case with the helicopter in this accident. This is recognised in Robinson Safety Notice 32 (see Appendix 6) High Winds and Turbulence, which was amended in May 2013 and February 2016, after one R66 and two R44 in-flight break-ups occurred in New Zealand. The following words were added:

- Flying in high winds or turbulence should be avoided [added February 2016]
- The helicopter is more susceptible to turbulence at light weight. Reduce speed and use caution when flying solo or lightly loaded [added May 2013]

4.5.27. The Safety Notices produced by Robinson apply to all three models, the R22, the R44 and the R66. Likewise, the same cautions regarding abrupt control movements and cyclic pushovers, and the prohibition of low-G pushovers, appear in all three flight manuals. The manufacturer recognised that these same risks applied across the three models and treated them the same when issuing safety notices and cautions. However, the training and experience requirements and limitations in regard to flying in turbulence had not been extended by the airworthiness authorities to cover all three models.

Finding

7. All three Robinson helicopter models are susceptible to low-G mast-bumping, and any preventive measures should apply to all of them.

4.6. Low-G right roll in Robinson helicopters

- 4.6.1. Test pilots flying the Robinson helicopters during certification, and instructors who had previously demonstrated⁵⁹ the effects of low-G to students, discovered that all three models had a tendency to roll to the right in low-G conditions, in some situations very rapidly. During the safety awareness training given to pilots, an instructional video supplied by Robinson states that in some cases the rate of right roll can reach nearly 100 degrees per second in less than a second⁶⁰.
- 4.6.2. A helicopter with a single main rotor is fitted with a tail rotor to counteract the torque reaction from the engine driving the main rotor, otherwise the helicopter would spin uncontrollably in the opposite direction to the main rotor. The tail rotor's thrust stops the helicopter spinning clockwise, but it creates a sideways thrust as a result and would make the helicopter drift in the same direction as the thrust. In the case of Robinson helicopters this is to the right (see Figure 7).

⁵⁹ Demonstrations of the effects of low-G in flight used to be carried out by instructors, but due to a number of incidents and one fatal accident during a demonstration they were determined to be too risky, and the effects should only be discussed on the ground now.

⁶⁰ Refer to www.gyronimosystems.com/SFAR.

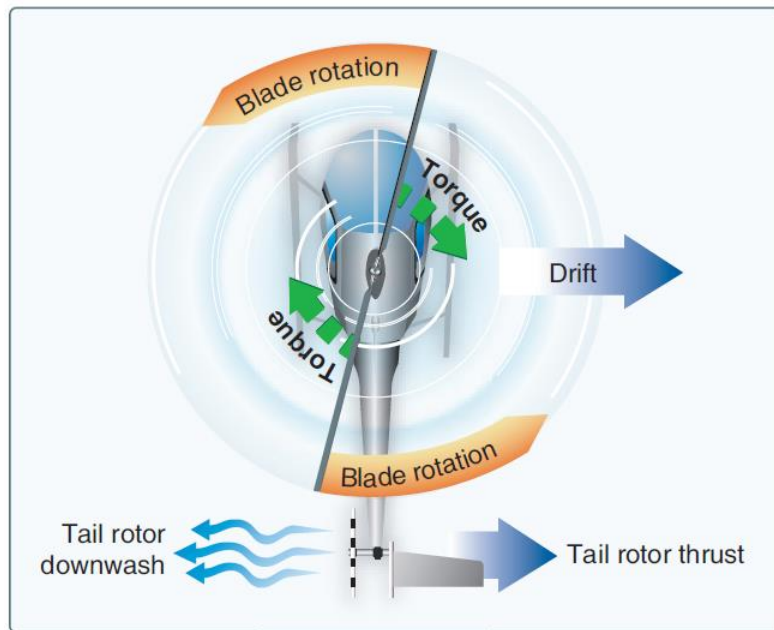

Figure 7
Tail rotor drift (source: FAA)

- 4.6.3. The horizontal tail rotor thrust acts in a line that is above the helicopter's centre of gravity, which if not compensated for would make the helicopter roll to the right. The sideways drift and roll are counteracted in flight by tilting the main rotor to the left slightly to produce a sideways component in the lift produced by the main rotor, which offsets the right drift and right roll from the tail rotor.
- 4.6.4. For the R44, the angle of the left tilt or teeter of the main rotor to offset tail rotor drift and correct the dissymmetry of lift across the main rotor is typically about 3 degrees in the cruise⁶¹. This leaves about 4.4 degrees of movement before the main rotor blade spindles contact the teeter stops at a combined total of 7.4 degrees of teetering. The maximum amount of teetering from the horizontal, before the blade spindles strike the driveshaft or mast, is 15.1 degrees.
- 4.6.5. The helicopter is 'underslung' at the teeter hinge, with its weight hanging from the teeter bolt. The main rotor provides a lifting force upwards and slightly to the left, which keeps the helicopter upright against the force of gravity and the tail rotor right roll, through a balanced pivot point at the teeter hinge. In a low-G condition, the main rotor loading is reduced and the forces are no longer in balance. There is not as much weight acting in a downwards direction to keep the helicopter slung upright underneath the main rotor, so the tail rotor thrust starts to roll the helicopter to the right. During a downdraught or cyclic pushover, the angle of attack of the main rotor blades is decreased due to the change in relative airflow (see Figure 8), and the amount of lift produced by the main rotor is reduced. As a result, the rotor is further unloaded and the sideways component of lift is reduced, allowing the tail rotor to roll the aircraft even faster to the right.

⁶¹ The actual angle depends on the airspeed and lateral centre of gravity; at a speed of 40 knots the angle is about 4 degrees, and at a speed of 120 knots it is about 2 degrees (based on a rotor flapping survey carried out by Robinson – RTR473).

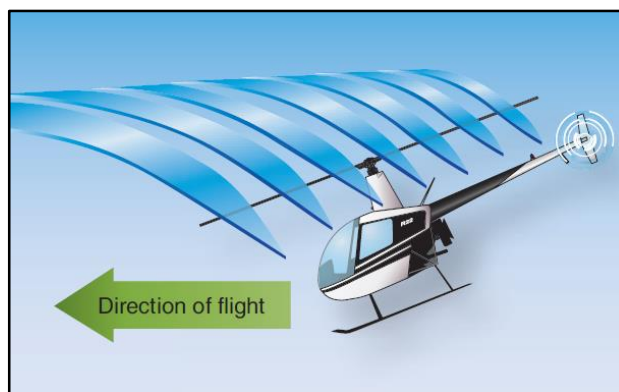

Figure 8
Change of relative airflow in a downdraught (source: FAA)

- 4.6.6. Another factor that affects the rate of tail rotor roll is the height of the tail in relation to the nose of the helicopter. The higher the tail, the greater the distance the tail rotor thrust line will be above the helicopter's centre of gravity, which results in a faster roll rate. This is one of the reasons why Robinson recommends slowing down in turbulence, as a lower speed equates to a lower tail (see Appendix 8). A slower speed also requires less power from the engine, so less thrust will be needed from the tail rotor to counteract the torque reaction, and the rate of roll will be slower.

Aerodynamic and rotor dynamic factors during low-G in severe turbulence

- 4.6.7. There have been no survivors of turbulence-related low-G mast-bumping accidents, and there is a lack of eye witnesses and evidence to confirm what exactly happens if a right roll fully develops in severe turbulence or downdraughts. The Commission has previously recommended to the FAA that the study into two-bladed, semi-rigid rotor system dynamic behaviour, including the effects of low-G, be reinstated and completed⁶². Until this is done, the actual behaviour of these rotor systems during prolonged or severe low-G encounters will not be fully understood. The following paragraphs discuss factors that are considered likely to contribute to an in-flight break-up during low-G-conditions in severe turbulence.
- 4.6.8. In a severe downdraught the weight acting on the main rotor is reduced by the sudden decrease in the G-loading, and the reduction in the angle of attack rapidly decreases the aerodynamic drag on the main rotor blades. This would unload the main rotor and therefore the engine, which would decrease the torque reaction experienced by the helicopter. The tail rotor would then be producing more thrust than required to balance the lower torque reaction from the engine, and the result would be a faster right roll due to the excess thrust from the tail rotor.
- 4.6.9. Low-G conditions due to cyclic pushovers are likely to occur at a slower rate and can be quickly corrected by removing the forward cyclic input and applying gentle aft cyclic to 'reload' the main rotor. In most situations when turbulence is encountered it is momentary, and the helicopter flies through the rough air into smooth air, reloading the main rotor. In both cases the effects of low-G are only experienced briefly and the right roll produced by the tail rotor does not fully develop, and stops once the rotor is reloaded. However, if a severe downdraught is encountered the low-G condition may persist for longer, allowing the tail rotor roll to fully develop and reach a high rate.
- 4.6.10. Because the main rotor is unloaded when the tail rotor thrust rolls the helicopter, it does not roll with the rest of the helicopter and initially remains level. The main rotor disc behaves like a gyroscope and would remain in its plane of rotation until a pitch change were made to the blades to change it. After a short delay, the main rotor disc would start to follow the tilting driveshaft due to the changing angles of attack on the blades. The angle of attack of the aft

⁶² Recommendation 005/16, inquiry report AO-2013-003.

blade would decrease and the forward blade's would increase due to the right tilting hub⁶³, which would result in a right tilt of the rotor disc. However, during flight testing at high airspeeds in normal (1G) flight, maximum roll rates through pitch angle changes were between 40 and 60 degrees per second, which is significantly less than the roll rates due to low-G (see 4.6.1. and 4.6.12.).

- 4.6.11. Once mast-bumping starts, a driveshaft that is tilting to the right begins to contact the main rotor blade spindles. The main rotor driveshaft is now trying to force the rotor disc to tilt to the right; however, this force is transmitted 90 degrees in the direction of rotation due to gyroscopic precession, which in the case of the Robinson is anticlockwise when viewed from above. The resultant force would make the rotor disc tilt forward, and again have the same effect as a cyclic pushover, making the low-G condition worse and aggravating the right roll.
- 4.6.12. During a study commissioned by the FAA and carried out by the Georgia Institute of Technology in the United States in 1995⁶⁴, a mathematical model⁶⁵ was used to assess the effects of flight control inputs and reduced G conditions to try to understand what happens during mast-bumping in R22s. It was calculated that during a low-G condition caused by a cyclic pushover lasting one second, after half a second the roll rate and teetering angles increase rapidly once the G-loading reduces to less than 0.5G, and the teeter stops are contacted a 10th of a second later. The calculated maximum roll rate was over 100 degrees to the right, and severe mast-bumping would have occurred after 0.1G was reached in less than a second.
- 4.6.13. The main rotor flapping surveys carried out by Robinson for the R22, R44 and R66 confirmed the high rates of roll that can be encountered during low-G conditions. The survey test flights included cyclic pushovers that caused a momentary reduction in G to between +0.3G and +0.6G, followed by an immediate aft cyclic recovery to reload the main rotor disc. Despite highly experienced test pilots conducting these tests, and the anticipated reduction in G that allowed them to prepare for and make a prompt recovery, the teeter limits were exceeded for both the R44 and the R66. Roll rates of up to 40 degrees per second were recorded during the brief excursions into reduced G. A sudden and sustained reduction in G below +0.3G would very likely lead to much higher roll rates and severe mast bumping.

Effects of Robinson main rotor design during a low-G right roll

- 4.6.14. When a Robinson helicopter rolls to the right and its main rotor remains level, as is the case initially with a right roll due to low-G, the pitch angles of the main rotor blades are changed through the pitch change links (see Figure 9). This secondary effect is due to the Robinson rotor design (see Appendix 4), as the pitch change horn is located outboard of the teeter hinge axis. This delta-three offset⁶⁶ arrangement introduces a teetering (flap)-pitch coupling of the main rotor blades, where a change in the teetering angle changes the pitch angle of the rotor blades. Other two-bladed, semi-rigid rotor designs such as that of the Bell 206 (see Appendix 4) have the pitch change input closer to or in line with the teeter hinge axis, so if the driveshaft is tilted due to turbulence or low-G, the change in blade pitch angle is smaller in comparison, or in some cases is non-existent.

⁶³ When the hub is aligned with the helicopter in a fore and aft direction, the hub is forced to tilt with the driveshaft as the teeter hinge bolt is perpendicular to the axis of roll. When the hub is in a left to right orientation, the hub is allowed to teeter as the teeter bolt is now parallel to the roll axis.

⁶⁴ FlightSim Project No. 950101, Georgia Institute of Technology Rotorcraft Flight Simulation Laboratory.

⁶⁵ The mathematical model was not validated by comparison with flight test data as this was not available

⁶⁶ Robinson designs include a delta-three offset or lag of about 18 degrees in the pitch change input, so instead of it being made 90 degrees in advance to compensate for gyroscopic precession, it is made 72 degrees in advance. This is to eliminate some 'undesirable characteristics' of rotor discs as they tilt forward, and during flight at high airspeeds.

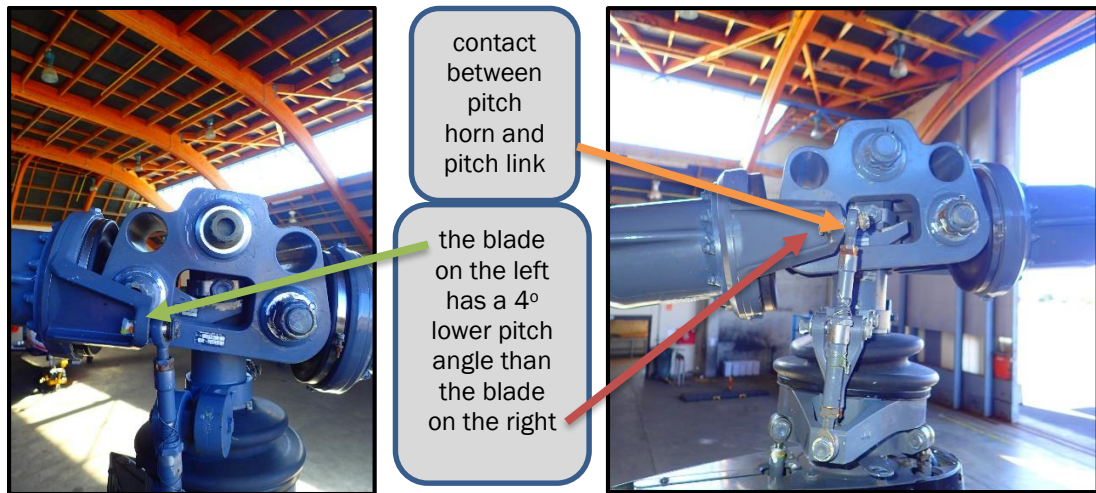

Figure 9

Teeter (flap)-pitch coupling (delta-three hinge) and contact between pitch link and pitch change horn

- 4.6.15. During normal operations with a vertical driveshaft, the teetering (flapping) to compensate for dissymmetry of lift across the rotor disc produces low teetering angles and a small teeter (flap)-pitch coupling. However, during a low-G right roll with a tilting driveshaft, high teetering angles and a larger teeter-pitch coupling is produced. The increase in the pitch angle on the rearward travelling blade creates a higher angle of attack and more lift, while the forward travelling blade experiences a decrease in angle of attack and less lift. The result is a force trying to tilt the blade to the right; however, due to gyroscopic precession (see Figure 10) the rotor disc will tilt forward, creating the same effect as a cyclic pushover and a worsening of the low-G condition.
- 4.6.16. Another unique design feature of the Robinson rotor head is that the pitch horn input is inboard of the coning hinge axis (see Figure 9 and Appendix 4), which means that a change in a blade's coning angle results in a change to its pitch angle. During the low-G conditions in the main rotor flapping survey flights, while the main rotor was partially unloaded, the coning angle of both blades was reduced by about 5 degrees, which would result in a decrease in the pitch angle of both blades by about 2 degrees. Although a small decrease, it would reduce the lift produced by the main rotor during low-G conditions and lead to a further reduction in G.

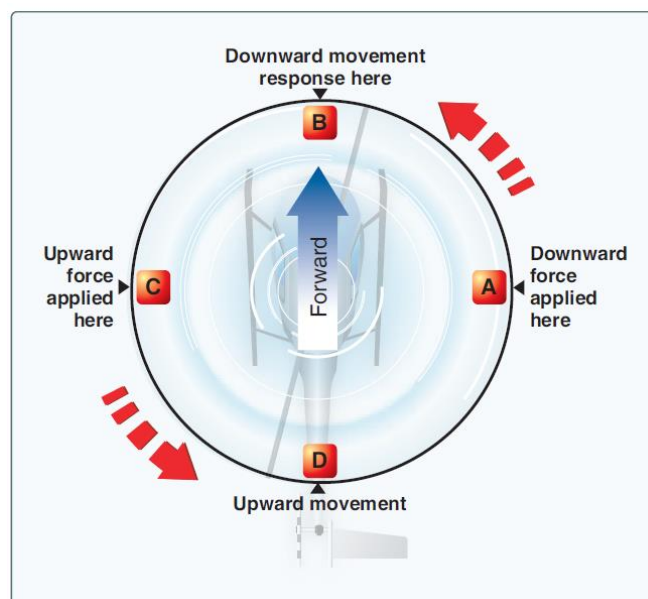

Figure 10

Gyroscopic precession (source: FAA)

- 4.6.17. At some point after the mast-bumping starts and the rotor hub has teetered beyond the limits, the pitch change links fail due to excessive reverse bending cycles and compression loads, likely after contact with the pitch change horns (see Figures 9 and 11) due to the limited range of movement the connection allows⁶⁷. This would render the main rotor blades uncontrollable in pitch, and they could assume extreme positive or negative angles of attack, causing rotor divergence. The centre of gravity of the blades is forward of the pitch change axis, which creates pitch instability during blade rotation. A blade rotating with a negative angle of attack produces lift in a downwards direction and would bend down into the cabin and underneath the helicopter with the airflow.



Figure 11
Contact between the pitch link and the pitch horn at the teeter limit (7.4 degrees)

- 4.6.18. When a main rotor blade strikes the cabin and skids under rotation, a massive torque overload occurs on the driveshaft, leading to a torsional failure and separation of the main rotor system. In the scenario described above, the time taken from entering the low-G condition and the development of the right roll, to the mast-bumping and main rotor separation, would likely be under a second, which is less than the reaction time of an alert pilot.

Finding

8. Due to their unique main rotor design, during a sudden and prolonged low-G condition Robinson helicopters can roll rapidly to the right and likely break up before a pilot can recover.

Low-G recovery techniques

- 4.6.19. When the tendency of Robinson helicopters to roll to the right during low-G conditions was first discovered, a recovery technique was developed by the manufacturer. During flight testing the low-G condition was induced by slowly pushing forward on the cyclic, which led to a right roll. This was relatively easy to anticipate and negate by removing the forward cyclic input to stop the low-G condition worsening, and applying gentle aft cyclic to 'reload' the rotor disc before the right roll developed further.
- 4.6.20. Once the rotor disc was reloaded the cyclic could be moved to the left to level the helicopter. However, if the cyclic were moved to the left before the rotor disc was reloaded, the main rotor

⁶⁷ Other two-bladed helicopters, such as the Bell 206, incorporate a connection that allows the main rotor to teeter well beyond the limits before the pitch link contacts the horn, meaning a mast separation is likely to happen before a rotor divergence can occur.

would respond to the cyclic input and tilt to the left but the helicopter would not follow, which could lead to a mast-bump.

- 4.6.21. The main issue with using this recovery technique during a low-G situation is that applying aft cyclic is not a pilot's natural reaction to a sudden right roll. During an unexpected abrupt roll to the right, the pilot's most instinctive reaction would be to try to level the helicopter by applying left cyclic. If the pilot did this in a low-G-induced abrupt right roll, the result could be mast-bumping and an in-flight break-up.
- 4.6.22. Following the prohibition of in-flight low-G demonstrations and practising low-G recovery techniques, the training of pilots on what to do in the event of encountering low-G was confined to verbal briefings only. The prohibition has likely made it harder for pilots to recognise a low-G-induced roll and for them to resist the most instinctive reaction to that roll. Instead they are told to use a technique that is not intuitive and not allowed to be demonstrated or practiced in-flight.
- 4.6.23. In some of the early mast-bumping accidents attributed to low-G, the suspected cause of the in-flight break-up was an 'incorrect' recovery technique applied by the pilot, such as moving the cyclic to the left while the rotor disc was still unloaded⁶⁸. However, in every case it has not been possible to determine if a pilot applied an incorrect recovery technique, applied the correct recovery technique, or did not have time to apply any recovery technique, before the helicopter broke up.
- 4.6.24. If a pilot is not braced for turbulence, or even if braced during severe turbulence or downdraughts, the pilot's unrestrained arms and legs can move the cyclic unintentionally during a violent upset, which could lead to a mast-bump. A pilot with a loosely restrained upper body is likely to remain upright initially during a sudden right roll, which could result in a left cyclic input as the helicopter rolls to the right. The seat belts normally⁶⁹ used in Robinson helicopters are three-point inertia reel automotive type units, which are not as effective in restraining occupants' upper bodies as four- or five-point harnesses with fixed-length self-locking lap belts. Although this was not a survivable accident, four- or five-point harnesses provide better restraint of occupants during accidents, and their use can reduce the severity of injuries.

Finding

9. A pilot's instinctive reaction to an unexpected right roll, or the unintentional movement of a pilot's limbs or upper body during severe turbulence or low-G, could lead to mast-bumping.

- 4.6.25. The recovery technique published in the flight manual was proven to be effective during flight testing in low-G conditions down to about +0.3G, which produced roll rates of up to 40 degrees per second. However, the reduced G was induced slowly and experienced momentarily, with the test pilot being able to anticipate the effects of the forward cyclic input and stop the roll before it fully developed. In a low-G condition brought on by turbulence or a strong downdraught, a pilot may not be able to anticipate the sudden reduction in G, and the right roll may occur suddenly and fully develop due to a longer exposure to the condition.
- 4.6.26. In response to the ongoing occurrence of mast-bumping accidents, and due to doubts over the effectiveness of the manufacturer's technique, some helicopter instructors in New Zealand developed or used alternative recovery techniques. Their actions were also partially driven by

⁶⁸ Refer Commission accident report 91-001, Robinson R22 Beta ZK-HDC, main rotor separation after mast-bumping in turbulence, near Hukerenui, 4 January 1991.

⁶⁹ A five-point harness is an option available on the R44 and R66, but most Robinson helicopters are manufactured with three-point seat belts, as this helicopter was.

the lack of effective in-flight training in the approved recovery technique, in addition to the prohibition of low-G demonstrations.

- 4.6.27. The instructor involved in the first R22 non-fatal mast-bumping incident in New Zealand used a right cyclic control input to tilt the rotor disc to the right to 'follow' the helicopter that had rapidly rolled to the right and pitched nose-down. This allowed him to prevent an in-flight break-up after mast-bumping began. However, a significant amount of height was lost during the recovery.
- 4.6.28. Another suggested technique involved lowering the collective lever to reduce the amount of tail rotor thrust, by decreasing engine power through the correlator⁷⁰. This recovery technique required co-ordination with the other flight controls, as a sudden reduction in the main rotor blade pitch angles creates secondary effects. The pitch angle of the tail rotors would have to be reduced through the tail rotor pedals, to avoid excess thrust acting against the reduced torque reaction and smaller horizontal component of lift from the main rotor.
- 4.6.29. The simultaneous reduction of both main rotor blade pitch angles would also lead to the rotor disc flapping forward⁷¹, and if not compensated for by immediately applying aft cyclic, the nose of the helicopter would drop and the low-G condition could worsen.
- 4.6.30. In response to the proposed alternative recovery techniques, Robinson Helicopters made the following comments about factors that can affect low-G conditions and the right roll:

1. *At slower speeds the effect of the turbulence, hence the amount of low-G, is greatly reduced.*
2. *Less power means less tail rotor thrust to roll the helicopter.*
3. *At slower speeds the location of the tail rotor relative to the aircraft's centre of gravity will reduce rolling tendencies.*

There seems to be a growing perception in New Zealand that lowering the collective is a preferable method and a more instinctive response to recover from a low-G condition.

We think the most important focus should be on the weightless feeling caused by the low-G condition, which can occur before the roll even starts and is when a recovery should be initiated.

Lowering the collective will cause a momentary pitching down of the nose, which could aggravate the roll.

- 4.6.31. Lowering the collective during a low-G condition will also further unload the rotor disc, delaying the reloading of the disc and the recovery to level flight. The reduction in lift from the main rotor would also mean a greater loss of height during recovery. The instructor involved in the second R22 non-fatal mast-bumping incident in New Zealand could only attempt a recovery by lowering the collective, because his student 'froze' and locked the cyclic control in a forward position. Again, a significant amount of height was lost during the recovery, but the helicopter did not break-up and the pilot was able to land safely.
- 4.6.32. The pilot of the helicopter in the Kahurangi accident was aware of the alternative technique of lowering the collective during a low-G encounter, as it had been discussed during his private pilot licence flight test. However, he had been taught the manufacturer's approved recovery technique during his Robinson safety awareness training. There is no way of knowing which recovery technique, if any, he used prior to the break-up.

⁷⁰ The correlator (or anticipator) helps to control the engine RPM within a set range and is a link between the collective lever and the engine's fuel control unit. Lowering the collective lever unloads the main rotor blades and therefore the engine, and the correlator senses the lever movement and reduces the engine power through the fuel control unit to help keep the RPM constant. It is vice versa for raising the collective lever and loading the main rotor blades. There is a slight delay in its operation.

⁷¹ When the angle of attack is reduced on the main rotor blades through the collective lever in forward flight, the amount of lift produced by the forward travelling blade is reduced more than the rearward travelling blade, resulting in the main rotor disc 'flapping forward' i.e. the front of the disc 'dives' due to gyroscopic precession. The nose of the helicopter also drops due to the reduced downforce from the horizontal stabiliser, as a result of the decreased downwash from the rotor.

- 4.6.33. The use of aft cyclic is not an intuitive reaction to an unexpected and sudden right roll (which in some cases can occur immediately after low-G is first felt), and this technique has not been proven in severe or prolonged low-G conditions. However, the manufacturer's low-G recovery technique has been proven during cyclic pushovers, and remains the only approved recovery technique. The key to applying the manufacturer's recovery technique successfully, is the early recognition or anticipation of low-G, and the immediate gentle application of aft cyclic before the right roll develops.

Finding

10. Although not an intuitive reaction to a sudden right roll, the aft cyclic technique is the only approved recovery technique, and should be used as soon as low-G is felt to 'reload' the main rotor disc and help reduce any right roll.

4.7. Conclusions

- 4.7.1. The pilot had completed the necessary safety awareness training for Robinson helicopters, and had flown the helicopter within the limitations in place at the time of the accident. The pilot had slowed the helicopter down as recommended by the manufacturer during an encounter with moderate or severe turbulence. He had been taught the manufacturer's approved recovery technique, and was aware of the alternative technique of lowering the collective during a low-G encounter. However, there is no way of knowing whether he used either technique during the event.
- 4.7.2. The helicopter was lightly loaded, which would have made it more susceptible to turbulence and the effects of reduced G. The helicopter started to descend northeast of Mt Arthur and in the lee of a ridgeline it had just crossed. It also turned to the right towards the lee of Mt Arthur and very likely encountered a severe downdraught, possibly while in a nose-low attitude⁷² due to an intentional descent by the pilot. The combination of the above factors occurring at the same time led to a sudden onset of low-G and a rapid roll to the right that was likely too fast for the pilot to recover from, resulting in mast-bumping and the in-flight break-up.

⁷² The helicopter would initially assume a nose-low attitude during a descent, whether the pilot used cyclic or collective input alone to initiate it.

5. Findings

- 5.1. A mast-bump occurred, which led to rotor divergence and the in-flight break-up.
- 5.2. The in-flight break-up was very unlikely to have been caused by low main rotor RPM (revolutions per minute).
- 5.3. An abrupt, inappropriate or inadvertent cyclic control input by the pilot could not be ruled out as having contributed to the in-flight break-up.
- 5.4. The actual wind and turbulence at the time and location of the accident were very likely to have been the same as, or stronger than, the forecast conditions.
- 5.5. The helicopter very likely encountered moderate to severe turbulence and an associated severe downdraught in the lee of Mt Arthur, which likely created a prolonged low-G condition.
- 5.6. Had a previous limitation on maximum wind speeds for inexperienced R44 pilots remained in place, as per that for R22 pilots, the pilot would have been prohibited from flying at the time of the accident due to the forecast strong winds and turbulence.
- 5.7. All three Robinson helicopter models are susceptible to low-G mast-bumping, and any preventive measures should apply to all of them.
- 5.8. Due to their unique main rotor design, during a prolonged or severe low-G condition Robinson helicopters can roll rapidly to the right, and likely break up before a pilot can recover.
- 5.9. A pilot's instinctive reaction to an unexpected right roll, or the unintentional movement of a pilot's limbs or upper body during severe turbulence or low-G, could lead to mast-bumping.
- 5.10. Although not an intuitive reaction to a sudden right roll, the aft cyclic technique is the only approved recovery technique, and should be used as soon as low-G is felt to 'reload' the main rotor disc and help reduce any right roll.

6. Safety actions

General

- 6.1. The Commission classifies safety actions by two types:
- (a) safety actions taken by the regulator, a manufacturer or an operator to address safety issues identified by the Commission during an inquiry that would otherwise result in the Commission issuing a recommendation
 - (b) safety actions taken by the regulator, a manufacturer or an operator to address other safety issues that would not normally result in the Commission issuing a recommendation.

Safety actions addressing safety issues identified during an inquiry

- 6.2. Nil.

Safety actions addressing other safety issues

- 6.3. In November 2016 Robinson released a Safety Alert (see Appendix 11) regarding low-G mast-bumping accidents, in response to a number of recent accidents worldwide involving the R44 and the R66. It drew attention to the prohibition of low-G pushover manoeuvres and the importance of applying gentle aft cyclic as soon as low-G is felt, and stated that “Low-G induced right roll indicates you are losing control of the helicopter”. Pilots are also reminded to slow down and avoid overreacting in turbulence.
- 6.4. At the same time Robinson also published Service Bulletins for the R44 and the R66 that instructed operators to install a placard below the airspeed indicators which reads:

DO NOT EXCEED 110 KIAS EXCEPT IN SMOOTH AIR

This new ‘maximum recommended airspeed’ has been introduced to ensure that pilots slow down from the normally higher cruise speeds of 130-140 Knots, to a safer cruise speed of 110 Knots when experiencing turbulence.

- 6.5. The Safety Alert contains previously published cautions regarding low-G pushovers and turbulence that are worth repeating, but they are already covered during the safety awareness training and are contained in the Safety Notices and normal procedures in the aircraft flight manual.
- 6.6. The new maximum recommended cruise speed for turbulence is significantly higher than the 60-70 knots that is recommended in Safety Notice 32 when experiencing ‘significant turbulence’. Although it is better to install an airspeed limitation placard like this in the cockpit, it may create confusion regarding the most appropriate speed to use in turbulence, and lead a pilot to believe that this higher airspeed is allowable in moderate or greater turbulence.
- 6.7. The pilot involved in this accident had slowed down to the recommended airspeed of 60-70 knots for significant turbulence, as published in Safety Notice 32, yet still encountered mast-bumping. This suggests that more robust measures are required to reduce the risk of low-G mast-bumping occurring in turbulence.

7. Recommendations

General

- 7.1. The Commission may issue, or give notice of, recommendations to any person or organisation that it considers the most appropriate to address the identified safety issues, depending on whether these safety issues are applicable to a single operator only or to the wider transport sector. In this case, recommendations have been issued to the Federal Aviation Administration (FAA), and the Civil Aviation Authority (CAA).
- 7.2. In the interests of transport safety, it is important that these recommendations are implemented without delay to help prevent similar accidents or incidents occurring in the future.

Previous recommendations

- 7.3. There have been a number of Safety Recommendations made worldwide as a result of previous mast-bumping accidents, which have resulted in the introduction of safety awareness training and the publishing of cautions and Safety Notices in the flight manuals to stress the dangers of low-G. The following Safety Recommendations related to low-G mast-bumping were made by the Commission between 2013 and 2016:

Recommendations to the FAA:

- amend section 2(b) of Special Federal Aviation Regulation No. 73 – Robinson R-22/R-44 Special Training and Experience Requirements to make it clear that dual instruction in the ‘effects of low-G manoeuvres’ is limited to discussion only, and to reiterate that deliberate in-flight reduced G conditions are prohibited (003/15)
- require Robinson Helicopter Company to amend its flight manuals to include the use of ‘Warning’ for those operating conditions and practices that involve a risk of personal injury or loss of life (007/15)
- extend the knowledge and training requirements of Special Federal Aviation Regulation No. 73 to pilots of the Robinson R66 helicopter (004/16)
- reinstate research into the dynamic behaviour of two-bladed, teetering, underslung rotor systems, taking full advantage of available technology, with the aim of achieving the original goal of National Transportation Safety Board recommendation A-96-12 (005/16).

Recommendations to the CAA:

- include the knowledge and training requirements of Special Federal Aviation Regulation No. 73, or an equivalent requirement, as a prerequisite for the issue of a Robinson R66 type rating (002/16)
- promptly publicise the recent changes to the Robinson R66 (and R44) Pilot’s Operating Handbooks that caution against flight in high winds and turbulence, and which advise pilots to reduce power and speed if turbulence is expected or encountered (011/16)

Recommendations to the Ministry of Transport:

- the Commission recommended to the Secretary for Transport that he promote, through the appropriate ICAO (International Civil Aviation Organization) forum, the need for cockpit video recorders and/or other forms of data capture in the cockpits of certain classes of helicopter to address this safety issue (014/16)

Watchlist

- 7.4. The Commission maintains a ‘Watchlist’ of the most pressing and current safety concerns in the three transport modes that it investigates: rail, marine and air. The Watchlist is published on the Commission’s website and updated regularly to capture emerging safety issues. In October 2016 the Commission added ‘Robinson helicopters: mast bumping accidents in NZ’ to the Watchlist (see Appendix 12), to reflect the Commission’s growing concern at the number of unexplained mast-bumping accidents involving Robinson helicopters.

Recommendations

- 7.5. There was an improvement in the low-G mast-bumping accident rates for Robinson helicopters after special training and limitations were introduced in the mid-1990s, but in New Zealand the rate has remained higher than in the United States. Worldwide, there were a number of low-G in-flight break-up accidents involving Robinson helicopters between 2011 and 2016, and some of these involved the R44 or R66 model.
- 7.6. It is likely that in some low-G situations, such as those found in severe turbulence and downdraughts, recovery may not be possible, even for an experienced and alert pilot. Therefore there needs to be a shift towards avoiding the conditions that can lead to these low-G situations developing.

Recommendation one

- 7.7. The limitations that have been in place on the R22 since the mid-1990s have helped to reduce the rate of R22 low-G mast-bump accidents, prevented inexperienced pilots flying in moderate or greater turbulence, and made it compulsory to slow down in turbulence.
- 7.8. Had a previous limitation on maximum wind speeds for inexperienced R44 pilots still been applicable, as per that for the R22, the pilot would have been prohibited from flying at the time of the accident due to the forecast strong winds and turbulence.
- 7.9. The involvement of experienced pilots, and the R44 and R66 models, in recent mast-bumping accidents suggests that those limitations should be extended to include the R44 and R66, and to all pilots of Robinson helicopters regardless of experience.
- 7.10. On 23 February 2017 the Commission recommended to the Administrator of the FAA that he:
- extend the limitations and requirements of FAA AD 95-26-04 that currently apply to the R22, in regard to operating in strong winds and turbulence, to the R44 and R66 models; and
 - extend those limitations and requirements so that they apply to all R22, R44 and R66 pilots regardless of their experience levels. (007/17)

Recommendation two

- 7.11. The consistently higher rate of mast-bumping accidents in New Zealand compared with the rest of the world highlights the increased risk of this type of accident occurring in New Zealand.
- 7.12. New Zealand's topography and prevailing wind conditions mean that for much of the country, and particularly the South Island, turbulent conditions can be encountered most of the time.
- 7.13. Owing to the increased risk of mast-bumping and the high number of Robinson helicopters flying in New Zealand, the CAA should take more effective action to reduce the risk of these accidents occurring in New Zealand.
- 7.14. On 23 February 2017 the Commission:
- gave notice to the Director of Civil Aviation that recommendation 007/17 had been made to the Administrator of the FAA, which recommended the FAA extend the limitations and requirements of FAA AD 95-26-04 to the R44 and R66, and to all Robinson pilots regardless of their experience levels
 - recommended to the Director of Civil Aviation that until such time as recommendation 007/17 is actioned by the FAA, he extend the limitations and requirements of FAA AD 95-26-04 to R44 and R66 helicopters in New Zealand, and to all pilots of Robinson helicopters in New Zealand regardless of their experience. (008/17)

On 10 March 2017, the Director of CAA replied:

The Director will consider whether the action sought by the Commission meets the legislative threshold that must be satisfied for the issue of an Airworthiness Directive. In doing this he will take into consideration the fact there have been no 'mast bump' accidents in NZ during the past two years. In addition, at the time of providing this response, the CAA has a team in the US working with the FAA Rotorcraft Directorate and the Robinson Helicopter Company on possible amendments to the Limitations sections of the Pilot Operating Handbooks of the Robinson series aircraft and improvements to safety awareness training. It may be that this work will provide an outcome that will meet the intent of the Commission's recommendation.

8. Key lessons

- 8.1. Pilots of two-bladed, semi-rigid rotor helicopters must be acutely aware of the risks and effects of encountering moderate or greater turbulence in strong winds, especially in the lee of high terrain.
- 8.2. If moderate or greater turbulence is encountered while flying a two-bladed, semi-rigid rotor helicopter, the pilot should consider landing and waiting for the conditions to improve.
- 8.3. Pilots of two-bladed, semi-rigid rotor helicopters should be aware of the helicopters' increased susceptibility to low-G conditions when lightly loaded, and the adverse effects that high power and a high tail rotor have on the rate of roll.
- 8.4. Pilots of Robinson helicopters should use the manufacturer's approved low-G recovery technique as soon as low-G conditions are felt.

9. Citations

FAA. (1995c). *Robinson R-22/R44 Special Training and Experience Requirements*. Washington, D.C.: Federal Aviation Administration.

NTSB. (1996). *Robinson Helicopter Company R22 Loss of Main Rotor Control Accidents, SIR-96/03*. Washington, D.C.: National Transportation Safety Board.

NTSB. (1996). *Special Investigation Report NTSB/SIR-96/03*. Washington, D.C. 20594: National Transportation Safety Board.

Schrage, D. P. (1995). *Simulation of Robinson R22 Helicopter for the Investigation of In-flight Rotor Dynamics*. Atlanta: Georgia Institute of Technology.

TAIC. (1991). *Aviation Inquiry 91-001: Robinson R22 Beta ZK-HDC, main rotor separation after mast-bumping in turbulence, near Hukerenui, 4 January 1991*. New Zealand: Transport Accident Investigation Commission.

TAIC. (2008). *Aviation Inquiry 08-007: Robinson R22, ZK-HXR, loss of control, Lake Wanaka, 1 November 2008*. New Zealand: Transport Accident Investigation Commission.

TAIC. (2011). *Aviation Inquiry 11-003: In-flight break-up ZK-HMU, Robinson R22, near Mt Aspiring, 27 April 2011*. New Zealand: Transport Accident Investigation Commission.

TAIC. (2013). *Aviation Inquiry AO-2013-003: Robinson R66 ZK-IHU, in-flight break-up, Kaweka Range, 9 March 2013*. New Zealand: Transport Accident Investigation Commission.

TAIC. (2103). *Aviation Inquiry AO-2013-005: In-flight loss of control, Robinson R22, ZK-HIE, near New Plymouth, 30 March 2013*. New Zealand: Transport Accident Investigation Commission.

TAIC. (2015). *Aviation Inquiry AO-2015-002: Mast bump and in-flight break-up, Robinson R44, ZK-IPY, Lochy River, near Queenstown, 19 February 2015*. New Zealand: Transport Accident Investigation Commission.

Appendix 1: Flight tracking data

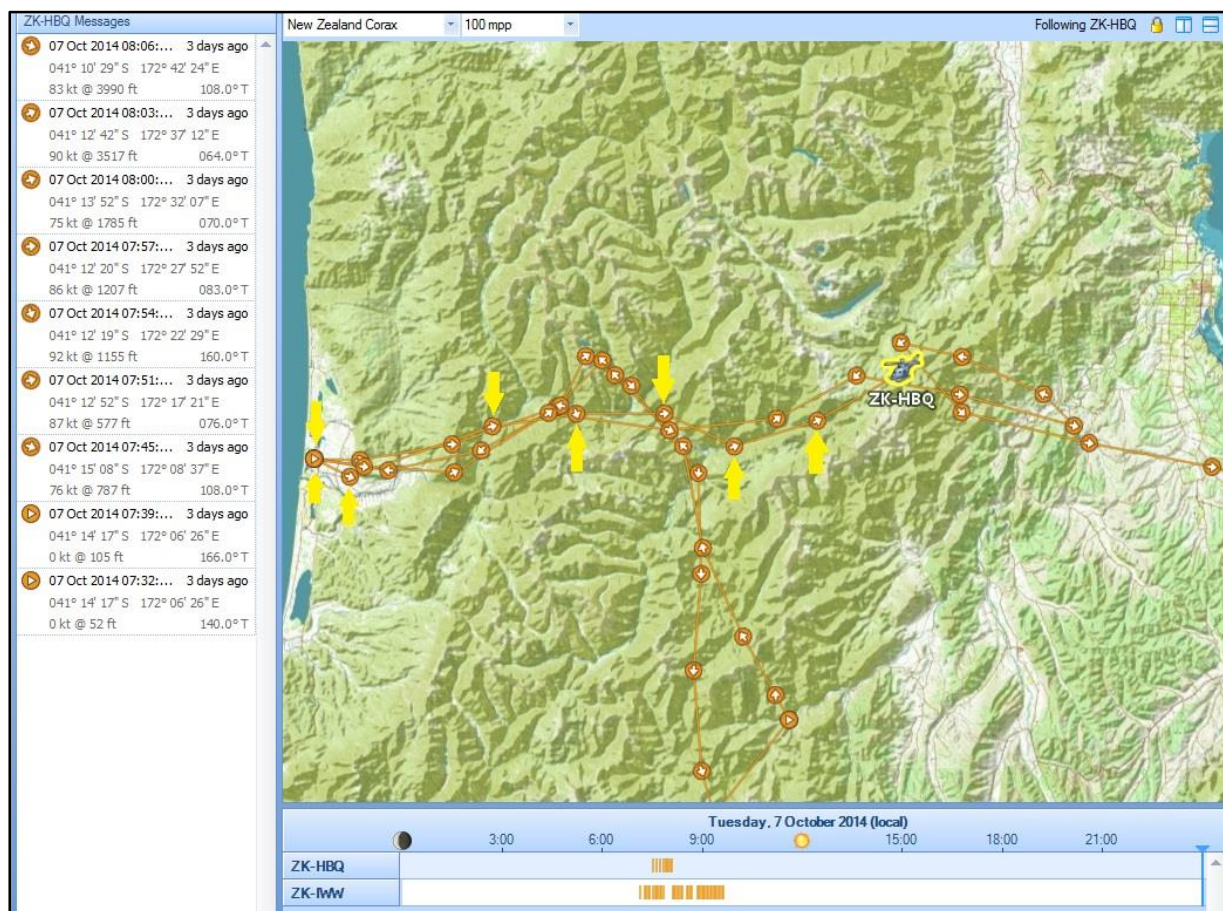

↓ ZK-HBQ TracPlus™ position reports (the others are from ZK-IWW, the second helicopter flying on the day).

Appendix 2: Weather forecasts (ARFOR, TAFs), actual reports (METARs), and SIGMETs

TN issued at 15:58 UTC 06-Oct-2014
FANZ70 NZKL 061558
ARFOR TN VALID 1600 TO 0100 UTC
BECOMING BECMG LATE MNG
1000 26020 VRB05
3000 26030 22020
5000 26040 MS01 22020 PS01
7000 26040 MS02 27020 ZERO
10000 22040 MS07 27040 MS05
FZL 4000FT RISING TO 8000FT MORNING.
VIS 30KM REDUCING TO 7000M IN SHRA.
CLD AREAS BKN CU 3000 TOPS 8000 WEST OF TASMAN MOUNTAINS.
WX ISOL SHRA IN THE WEST CLEARING LATE MORNING.
TURB OCNL MOD SEVERE AS PER SIGMET EASING AFTERNOON.
REMARK LOW LEVEL WINDS DON'T EASE ABT CAPE FAREWELL LATE MORNING.

NZWS issued at 14:11 UTC 06-Oct-2014
TAF NZWS 061411Z 0613/0706 22015KT 20KM -SHRA SCT030
TEMPO 0613/0620 7000 SHRA
BECMG 0622/0700 22005KT
BECMG 0704/0706 36015KT
2000FT WIND 22035KT
BECMG 0618/0620 22025KT
BECMG 0700/0702 VRB05KT
BECMG 0704/0706 36025KT
QNH MNM 1007 MAX 1016

NZNS issued at 14:07 UTC 06-Oct-2014
TAF NZNS 061407Z 0613/0706 22008KT 30KM FEW030
BECMG 0622/0700 02015KT
2000FT WIND 22035KT
BECMG 0622/0700 22015KT
QNH MNM 1007 MAX 1016

METAR NZNS 061800Z AUTO 21008KT 20KM BKN250/// 06/02 Q1011
METAR NZWS 061800Z AUTO 16004KT 18KM -RA SCT032/// SCT042/// BKN049/// 08/06
Q1013

METAR NZNS 061830Z AUTO 21009KT 20KM OVC240/// 08/02 Q1012
METAR NZWS 061830Z AUTO 20007KT 160V260 8000 -RA SCT030/// BKN038///
OVC050/// 08/06 Q1014

METAR NZNS 061900Z AUTO 21011KT 20KM SCT240/// 08/02 Q1013
METAR NZWS 061900Z AUTO 19004KT 17KM -RA SCT034/// BKN042/// BKN055/// 08/07
Q1015

METAR NZNS 061930Z AUTO 23010KT 20KM NCD 09/02 Q1013
METAR NZWS 061930Z AUTO 20003KT 19KM FEW030/// SCT036/// BKN049/// 09/07
Q1015

METAR NZNS 062000Z AUTO 21013KT 20KM NCD 11/02 Q1013
METAR NZWS 062000Z AUTO 21002KT 20KM FEW030/// SCT048/// 10/07 Q1015

METAR NZNS 062030Z AUTO 22012KT 180V250 20KM NCD 12/01 Q1013
METAR NZWS 062030Z AUTO 21004KT 150V260 20KM SCT049/// 11/07 Q1016

NZZC issued at 17:36 UTC 06-Oct-2014
WSNZ21 NZKL 061736
NZZC SIGMET 19 VALID 061736/062136 NZKL-
NZZC NEW ZEALAND FIR SEV TURB FCST S OF S3840 E17759 AND N OF S4329 E17232
FL120/350 MOV E 20KT NC=

NZZC issued at 17:36 UTC 06-Oct-2014
WSNZ21 NZKL 061736
NZZC SIGMET 20 VALID 061736/062136 NZKL-
NZZC NEW ZEALAND FIR SEV TURB FCST S OF S3425 E17303 AND NE OF LINE S4329
E17232 - S4144 E17135 SFC/FL100 MOV E 20KT NC=

Appendix 3: NTSB special investigation

1. In 1994, concerned by the number of unexplained R22 accidents that involved a mast-bump or low main rotor RPM ('loss of main rotor control'), the NTSB commenced a special investigation to examine those accidents and the certification history and handling qualities of the R22. The investigation was later expanded to include similar R44 accidents.
2. In response to the initial recommendations made by the NTSB during the investigation, the FAA issued airworthiness directives (ADs) that limited R22 and R44 operations in high winds and turbulence. The final versions, AD 95-26-04 for the R22 and AD 95-26-05 for the R44, were issued in 1996. AD 95-26-04 was later made permanent, but AD 95-26-05 was rescinded in 2004 after a review of the R44 in-service experience⁷³.
3. AD 95-26-04 included, in part, the following information:
 - Until the FAA completes its research into the conditions and aircraft characteristics that lead to main rotor blade / fuselage contact accidents, and corrective type design changes and operating limitations are identified, Model R22 pilots are strongly urged to become familiar with the following information and comply with these recommended procedures.
 - Main Rotor Stall: ... Any flight condition that creates excessive angle of attack on the main rotor blades can produce a stall. Low main rotor RPM, aggressive manoeuvring, high collective angle (... high density altitude, over-pitching ... during climb, or high forward airspeed) ... The effect of these conditions can be amplified in turbulence.
 - Mast Bumping: Mast bumping may occur with a teetering rotor system when excessive main rotor flapping results from low 'G' ... or abrupt control input ... High forward airspeed, turbulence and excessive sideslip can accentuate the adverse effects of these control movements.
 - To avoid these conditions, pilots are strongly urged to follow these recommendations:
 - Maintain cruise airspeeds between 60 [knots] and less than 0.9 [of maximum permitted airspeed] ...
 - Avoid large, rapid forward cyclic inputs in forward flight, and abrupt control inputs in turbulence.
4. The FAA also issued SFAR 73 in 1995 to mandate specified awareness and flight training for all pilots of R22 and R44 helicopters. SFAR 73 required that the special training be delivered by an authorised instructor and completed by every pilot before "manipulating the controls" of a Robinson helicopter. SFAR 73 also stipulated that an annual flight review be undertaken in the applicable helicopter type until a specified minimum experience was attained, after which biannual flight reviews, in the relevant type, were required⁷⁴. SFAR 73 was made permanent in June 2009.
5. The NTSB special investigation report noted that the FAA had conducted three special certification reviews of the R22 between 1982 and 1994. Each review had concluded that the R22 was safe "when flown within its operating limitations". However, the NTSB found no evidence that the FAA had acted on internal recommendations regarding the certification testing of light helicopters and their dynamic stability during manoeuvres (NTSB, 1996, pp. 20, 21).
6. Robinson conducted flight tests of the R22 in 1982 to survey rotor teeter clearances and the response to flight control inputs, and concluded that the R22 main rotor system "would not stall, exceed its teeter clearance, or contact the tail boom when the aircraft is flown within its approved limitations" (NTSB, 1996, p. 23). Similar tests conducted with the R44 in 1995 concluded that "the R44 could safely perform any nominal flight activity without main rotor divergence tendencies" (NTSB, 1996, p. 23). However, because "the tests were not (and could not safely be) conducted to determine the [R44's] response to large, abrupt cyclic inputs ... the flight test did not provide the

⁷³ Robinson took other actions to improve the R22, including the installation of an electronic fuel control governor (which helps to control main rotor speed), a more powerful engine, and an automatic carburettor heat control.

⁷⁴ On 11 June 2015 Robinson published a tutorial on SFAR 73 at www.gyronimosystems.com/SFAR.

data needed to determine the mechanism for the blade diverging into the body” (NTSB, 1996, p. 23).

7. The obvious constraints on hazardous flight testing led to a mathematical simulation model of R22 main rotor dynamics being developed by the Georgia Institute of Technology’s School of Aerospace Engineering (Schrage, 1995)⁷⁵. The project ended due to a lack of funds before the model was fully validated or all of the areas of interest had been researched (for example, divergent modes of the rotor that led to blade-fuselage strikes) (NTSB, 1996, p. 24). However, for those areas of the flight envelope⁷⁶ that were validated, the model verified the theory that pushovers (which cause a low-G condition) could lead to a main rotor blade striking the fuselage.
8. The Georgia Institute of Technology report stated that “within the scope of this investigation no [static droop] stop contact or rotor/tail boom strikes occurred in the normal operating range of the helicopter”, but some of the scenarios did produce notional mast-bumps and hub contact with the droop stop (Schrage, 1995, p. 127).
9. The report concluded, in part (Schrage, 1995, p. 133):

The results from the cases executed in this report fall into three basic categories: (i) cases where no excessive flapping was observed, (ii) cases where larger than normal flapping behavior was observed, and the various limits of the blade and hub were exceeded, and (iii) cases where there was indication of a definite tail boom strike. The primary objective of many of the cases executed in this investigation was to find as many flight conditions as possible which fall in the last category. As one would expect these cases correspond to maneuvers with large pilot inputs, cases where rotor stall is a factor, severe gusts among others. Thus, some cases have been identified, where the simulation model seems to indicate a potential failure mode. These are primarily related to rotor stall at lower rpm ... In case of pushover scenarios, simulation results indicate a sensitivity to abrupt aft cyclic under conditions of deep rotor stall. Gust under moderate conditions, seems not to be a problem even at high gross weights.

10. The Georgia Institute of Technology report recommended further areas of study, but the FAA confirmed in 2013 that the intended research had not been completed.
11. Studies by the NTSB and manufacturers have shown that a low-inertia main rotor blade can strike the fuselage in just a few revolutions. It would take less than half a second for an R44 main rotor operating at the normal speed of 408 RPM.
12. The NTSB’s special investigation “found no direct evidence of an unstable blade or rotor system design. The extensive operational history, the wreckage evidence, flight tests, and computer simulations indicate that a dynamically unstable main rotor system is unlikely” (NTSB, 1996, p. 25). The NTSB recognised that many factors, including large, abrupt pilot control inputs, were possible explanations for the accidents.
13. The summary of the NTSB special investigation report stated, in part (NTSB, 1996, p. 27):

The Board is also concerned that in the future, other highly responsive helicopters are likely to be designed and built that may have characteristics similar to the R22. Consequently, the Safety Board believes that as a part of the certification process for highly responsive helicopters, the FAA should establish operational requirements, student pilot training requirements, and instructor pilot requirements, such as those imposed on the R22 and R44, to ensure that pilots at all levels of qualification and skills can adequately operate the helicopter. The Safety Board concludes that although the response rate of the R22 to cyclic input is not unsafe so long as the special operating rules remain in place, there is a need for the FAA to consider the responsiveness of helicopters (especially lightweight, high performance helicopters such as the R22) as part of the certification process to determine if special operating rules or guidance are necessary. Thus, the Safety Board believes that the FAA should require helicopter

⁷⁵ Retrieved 15 December 2014 from <http://hdl.handle.net/1853/52548>.

⁷⁶ The flight envelope (or operating envelope) is the range of airspeeds, load factors and altitudes for an aircraft, as established by the design and verified during certification testing.

manufacturers to provide data on the response of helicopters to large, abrupt cyclic inputs as a part of the certification process and require operational limitations or other measures for those helicopters that are more responsive, such as the R22.

14. The NTSB made the following recommendations to the FAA at the conclusion of its special investigation (NTSB, 1996, p. 31):

Ensure that Special Federal Aviation Regulation 73, the Flight Standardization Board specifications, and the airworthiness directives applicable to the operation of the R22 and R44 are made permanent (A-96-9)

Establish, for future certification of highly responsive helicopters, operational requirements, student pilot training requirements, and instructor pilot requirements, such as those imposed for the R22 and R44, necessary to ensure that pilots of all levels of qualification and skills can adequately operate the helicopter (A-96-10)

Require helicopter manufacturers to provide data on the response of helicopters to flight control inputs to be used as part of the certification process, and require operational limitations or other measures for those helicopters that are highly responsive (A-96-11)

In conjunction with the National Aeronautics and Space Administration [NASA], continue the development of the simulator model of lightweight helicopters, using flight tests and whirl tower tests as needed to validate the model, to create a national resource tool for the study of flight control systems and main rotor blade dynamics. If any unusual main rotor blade system characteristics are found, ensure that the information and data gathered are disseminated to the appropriate agencies and industry (A-96-12).

15. The status of recommendation A-96-9 was changed to 'Closed – acceptable action' in December 1996 after the FAA agreed to make the listed documents permanent.
16. The status of recommendation A-96-10 was also changed to 'Closed – acceptable action' in December 1996 after the FAA committed to establishing a Flight Standardization Board for each newly certificated helicopter to determine the operational and pilot training requirements.
17. In response to recommendation A-96-11, the FAA twice amended Advisory Circular 27-1, Certification of Normal Category Rotorcraft. The changes added guidance to manufacturers on a means of compliance with regulation 14CFR27.661, which requires rotor-fuselage clearance "for any operating condition". In a letter to the NTSB seeking closure of the recommendation, the FAA stated that the guidance material addressed large control inputs by pilots and low-G manoeuvres. As a result, on 17 March 2000 the NTSB changed the recommendation status to 'Closed – acceptable action'.
18. Recommendation A-96-12 was closed by the NTSB in 1998 after it received a submission from the FAA, which read in part⁷⁷:

The FAA has reviewed the merits of developing a simulation tool for aiding the certification of future helicopter flight control systems/blade dynamics and has determined that such a tool would have limited application. This determination considered the actions that have already been accomplished and the status of the NASA initiative. The behavior of certain rotor system configurations may become unpredictable and dangerous beyond certain boundaries. For this reason, the FAA established a certified operating envelope. Due to the combination of extremely complex flight control inputs, non-linear environmental gust effects and the inherent difficulties in various rotor blade airfoil/hub designs, development of a single generic mathematical model to predict acceptable flight limitations would have limited application. Subsequent

⁷⁷ www.nts.gov/safety/safety-recs/_layouts/ntsb.recsearch/Recommendation.aspx?Rec=A-96-012, accessed 17 July 2015.

validation of the math model would involve extensive testing with significant risk to flight safety.

19. The NTSB accepted that “the bulk of the effort towards continued math modelling of lightweight rotor systems will be conducted by [NASA] and the FAA has reached the limits of its technical involvement”.

Appendix 4: Two-bladed, semi-rigid teetering rotor system dynamics

All photos sourced from www.copters.com.

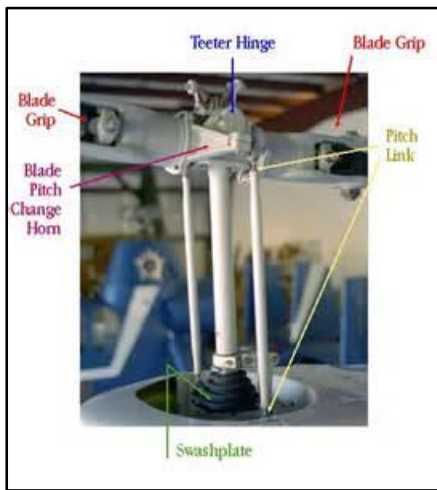

Figure 1 Bell main rotor controls

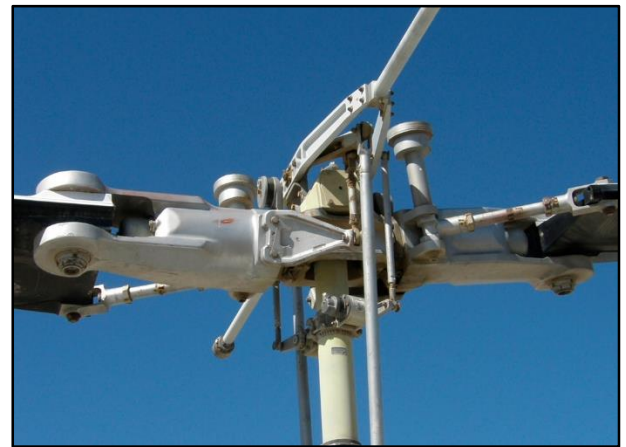

Figure 2 Bell rotor head with pitch link input in line with teeter hinge

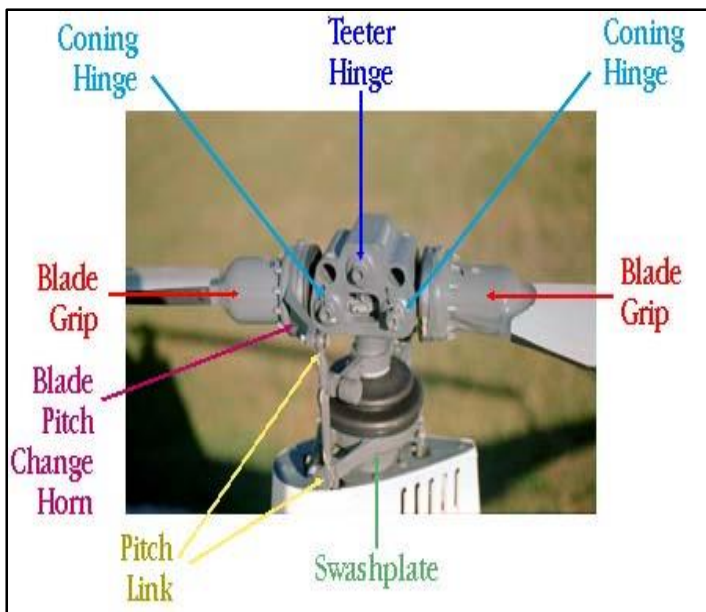

Figure 3 Robinson main rotor control inputs

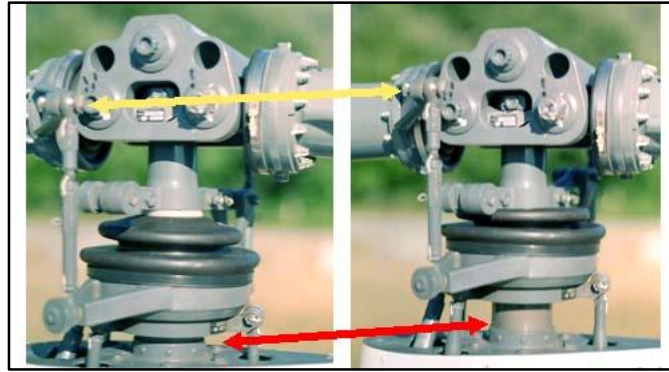

Figure 4 R44 pitch link input outboard of teeter hinge and inboard from coning hinge

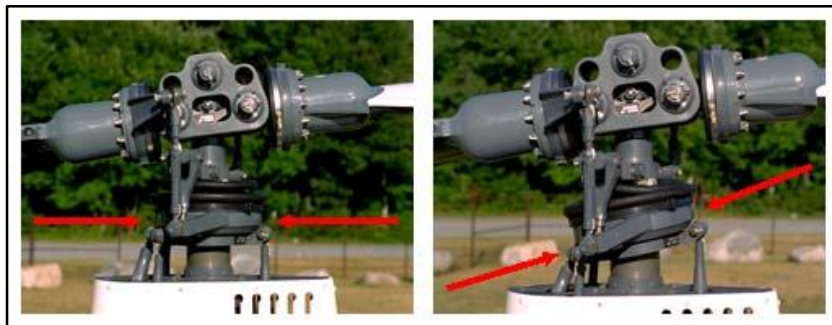

Figure 5 Teetering

Changing main rotor blade pitch angles



Pitch changes made through the collective lever adjust both blades simultaneously by raising or lowering the swashplate⁷⁸ and keeping it level.



Pitch changes made through the cyclic control (shown in a forward position) by adjusting the angle of the swashplate. Blade pitch angles change differentially as the blades rotate around the tilted swashplate. Pitch inputs are made 90 degrees (72 degrees for Robinsons) in advance to compensate for gyroscopic precession. The rotor disc then tilts in the same direction as the swashplate.

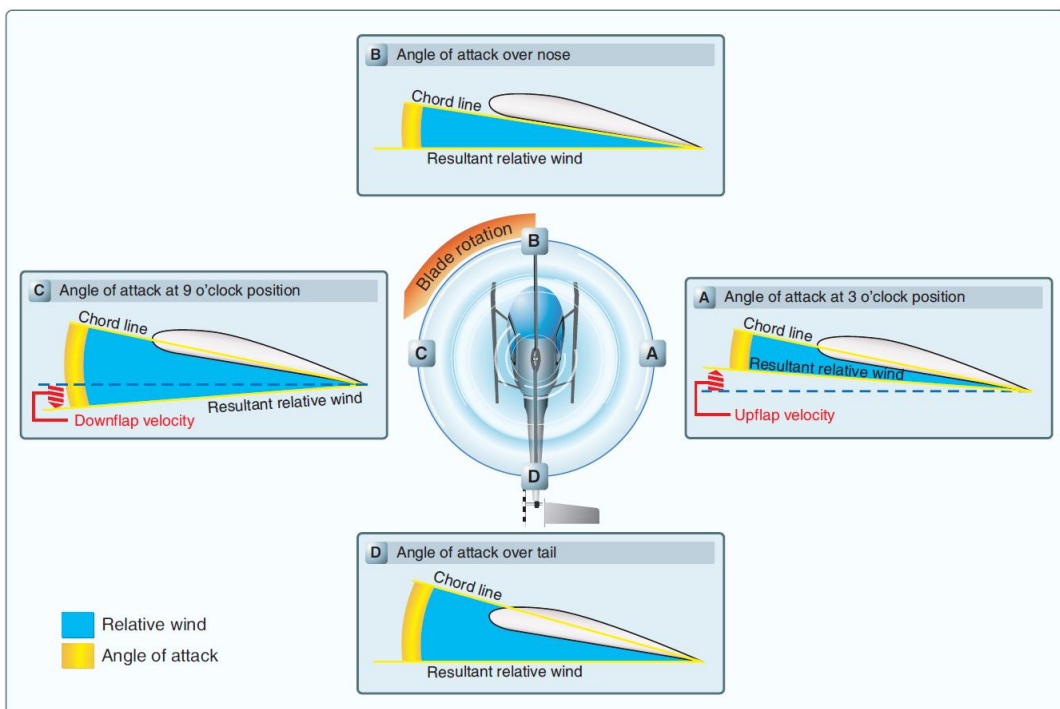

Main rotor blade angle of attack during normal teetering (flapping) for dissymmetry of lift.

⁷⁸ A swashplate is a device that translates cyclic and collective control inputs to the main rotor.

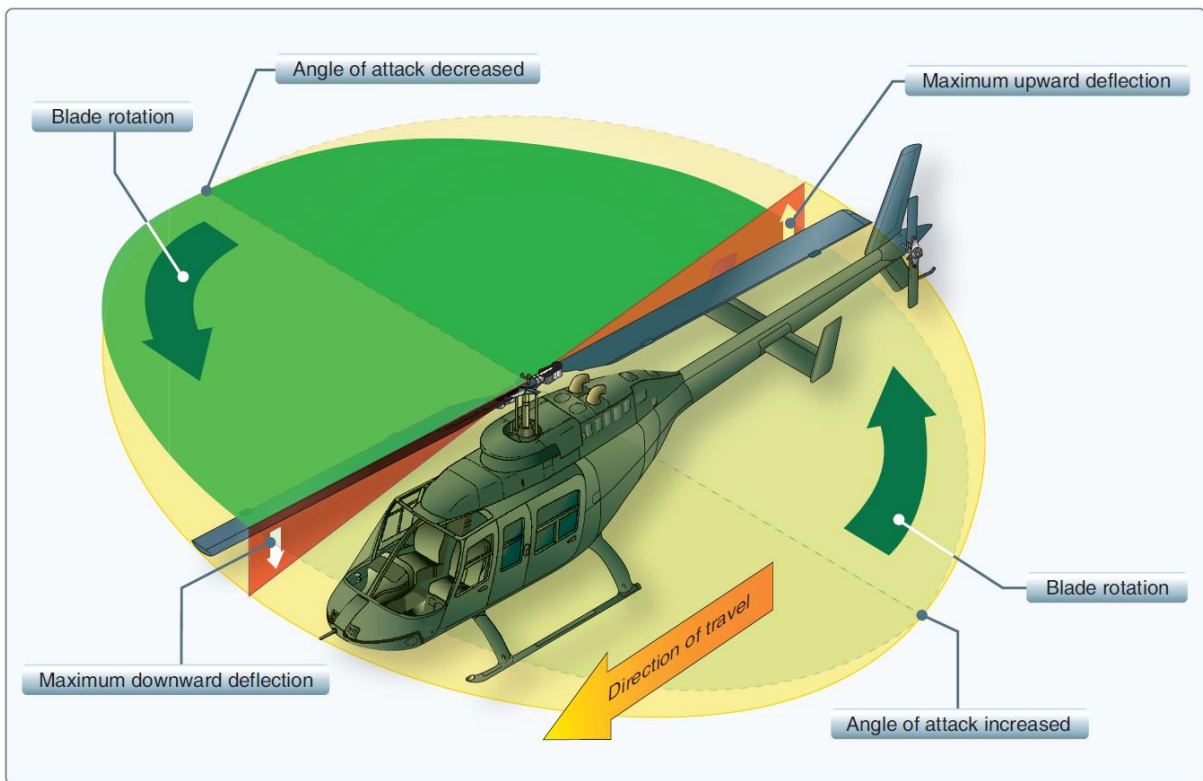

Effects of gyroscopic precession in a rotor system (forward cyclic input) (source: FAA)

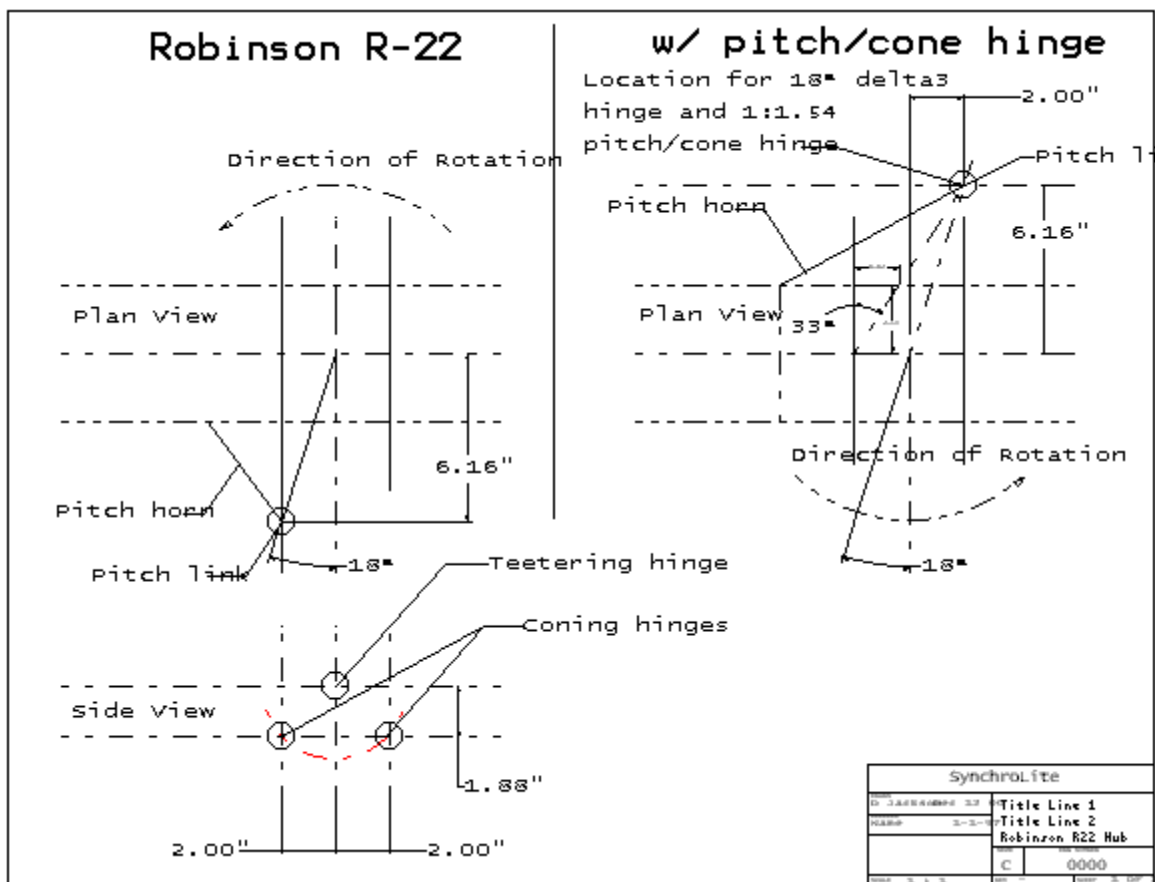

Robinson rotor head delta-three hinge (source: www.unicopter.com)

Appendix 5: Robinson in-flight break-ups in New Zealand

Investigation reference	Report title
*OAAI ⁷⁹ 87-112	Robinson R22 ZK-HVG, Waimakariri River, Canterbury, 24 November 1987
*TAIC 89-065	Robinson R22 ZK-HYX, failed to return from scheduled flight, Whitford Forest, 1 August 1989
*TAIC 91-001	Robinson R22 Beta ZK-HDC, main rotor separation after mast-bumping in turbulence, near Hukerenui, North Auckland, 4 January 1991
TAIC 93-001	Robinson R22 Beta ZK-HCT, 38 km north-west of Kaikoura, 11 January 1993
CAA 96/3239	Robinson R22 Beta ZK-HDD, Matawai, Gisborne, 5 December 1996
CAA 02/71	Robinson R22 Beta ZK-HEZ, Balfour Range, near Fox Glacier, 14 January 2002
CAA 03/127	Robinson R22 Beta ZK-HUL, Masterton, 17 January 2003
*CAA 04/39	Robinson R22 Beta ZK-HXT, 10 km north-east of Taupo, 10 January 2004
*CAA 06/633	Robinson R22 Beta ZK-HLC, 40 km north-west of Wanaka, 5 March 2006
*TAIC 08-007	Robinson R22 Alpha ZK-HXR, loss of control, Lake Wanaka, 1 November 2008
CAA 10/3987	Robinson R22 Beta ZK-HIP, loss of rotor RPM, Bluff Harbour, 14 October 2010
TAIC 11-003	Robinson R22 Beta ZK-HMU, in-flight break-up, near Mt Aspiring, 27 April 2011
*CAA 12/4957	Robinson R22 Beta ZK-HCG, loss of main rotor control, Cardrona Valley, Wanaka, 8 November 2012
*TAIC AO-2013-003	Robinson R66 ZK-IHU, in-flight break-up, Kaweka Range, 9 March 2013
*TAIC AO-2014-006	R44 ZK-HBQ, in-flight break-up, Kahurangi National Park, 7 October 2014
*TAIC AO-2015-002	R44 ZK-IPY, in-flight break-up, Lochy River, near Queenstown, 19 February 2015

*Low-G mast-bumping in-flight break-ups

⁷⁹ Office of Air Accidents investigation (predecessor to TAIC).

R22 non-fatal low-G mast-bumping incidents

TAIC AO-2013-005	R22 Beta ZK-HIE, in-flight loss of control, near New Plymouth, 30 March 2013
CAA 15/1229	Robinson R22 Beta ZK-HMW, mast-bump, Clevedon, 19 March 2015

Safety Notice SN-10

Issued: Oct 82 Rev: Feb 89; Jun 94

FATAL ACCIDENTS CAUSED BY LOW RPM ROTOR STALL

A primary cause of fatal accidents in light helicopters is failure to maintain rotor RPM. To avoid this, every pilot must have his reflexes conditioned so he will instantly add throttle and lower collective to maintain RPM in any emergency.

The R22 and R44 have demonstrated excellent crashworthiness as long as the pilot flies the aircraft all the way to the ground and executes a flare at the bottom to reduce his airspeed and rate of descent. Even when going down into rough terrain, trees, wires or water, he must force himself to lower the collective to maintain RPM until just before impact. The ship may roll over and be severely damaged, but the occupants have an excellent chance of walking away from it without injury.

Power available from the engine is directly proportional to RPM. If the RPM drops 10%, there is 10% less power. With less power, the helicopter will start to settle, and if the collective is raised to stop it from settling, the RPM will be pulled down even lower, causing the ship to settle even faster. If the pilot not only fails to lower collective, but instead pulls up on the collective to keep the ship from going down, the rotor will stall almost immediately. When it stalls, the blades will either "blow back" and cut off the tail cone or it will just stop flying, allowing the helicopter to fall at an extreme rate. In either case, the resulting crash is likely to be fatal.

No matter what causes the low rotor RPM, the pilot must first roll on throttle and lower the collective simultaneously to recover RPM **before** investigating the problem. It must be a conditioned reflex. In forward flight, applying aft cyclic to bleed off airspeed will also help recover lost RPM.

Safety Notice SN-11

Issued: Oct 82 Rev: Nov 00

LOW-G PUSHOVERS - EXTREMELY DANGEROUS

Pushing the cyclic forward following a pull-up or rapid climb, or even from level flight, produces a low-G (weightless) flight condition. If the helicopter is still pitching forward when the pilot applies aft cyclic to reload the rotor, the rotor disc may tilt aft relative to the fuselage before it is reloaded. The main rotor torque reaction will then combine with tail rotor thrust to produce a powerful right rolling moment on the fuselage. With no lift from the rotor, there is no lateral control to stop the rapid right roll and mast bumping can occur. Severe in-flight mast bumping usually results in main rotor shaft separation and/or rotor blade contact with the fuselage.

The rotor must be reloaded before lateral cyclic can stop the right roll. To reload the rotor, apply an immediate gentle aft cyclic, but avoid any large aft cyclic inputs. (The low-G which occurs during a rapid autorotation entry is not a problem because lowering collective reduces both rotor lift and rotor torque at the same time.)

Never attempt to demonstrate or experiment with low-G maneuvers, regardless of your skill or experience level. Even highly experienced test pilots have been killed investigating the low-G flight condition. Always use great care to avoid any maneuver which could result in a low-G condition. Low-G mast bumping accidents are almost always fatal.

NEVER PERFORM A LOW-G PUSHOVER!!

Safety Notice SN-24

Issued: Sep 86 Rev: Jun 94

LOW RPM ROTOR STALL CAN BE FATAL

Rotor stall due to low RPM causes a very high percentage of helicopter accidents, both fatal and non-fatal. Frequently misunderstood, rotor stall is not to be confused with retreating tip stall which occurs only at high forward speeds when stall occurs over a small portion of the retreating blade tip. Retreating tip stall causes vibration and control problems, but the rotor is still very capable of providing sufficient lift to support the weight of the helicopter.

Rotor stall, on the other hand, can occur at any airspeed and when it does, the rotor stops producing the lift required to support the helicopter and the aircraft literally falls out of the sky. Fortunately, rotor stall accidents most often occur close to the ground during takeoff or landing and the helicopter falls only four or five feet. The helicopter is wrecked but the occupants survive. However, rotor stall also occurs at higher altitudes and when it happens at heights above 40 or 50 feet AGL it is most likely to be fatal.

Rotor stall is very similar to the stall of an airplane wing at low airspeeds. As the airspeed of an airplane gets lower, the nose-up angle, or angle-of-attack, of the wing must be higher for the wing to produce the lift required to support the weight of the airplane. At a critical angle (about 15 degrees), the airflow over the wing will separate and stall, causing a sudden loss of lift and a very large increase in drag. The airplane pilot recovers by lowering the nose of the airplane to reduce the wing angle-of-attack below stall and adds power to recover the lost airspeed.

The same thing happens during rotor stall with a helicopter except it occurs due to low rotor RPM instead of low airspeed. As the RPM of the rotor gets lower, the angle-of-attack of the rotor blades must be higher to generate the lift required to support the weight of the helicopter. Even if the collective is not raised by the pilot to provide the higher blade angle, the helicopter will start to descend until the

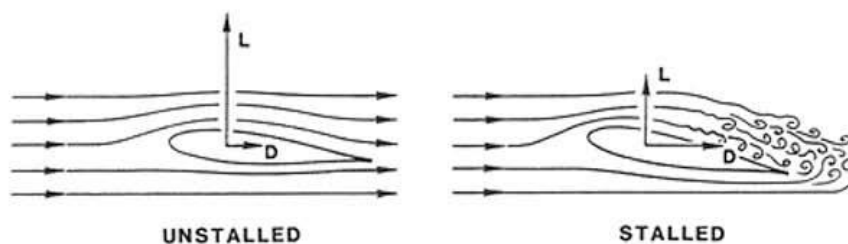

Wing or rotor blade unstalled and stalled.

Safety Notice SN-24 (continued)

upward movement of air to the rotor provides the necessary increase in blade angle-of-attack. As with the airplane wing, the blade airfoil will stall at a critical angle, resulting in a sudden loss of lift and a large increase in drag. The increased drag on the blades acts like a huge rotor brake causing the rotor RPM to rapidly decrease, further increasing the rotor stall. As the helicopter begins to fall, the upward rushing air continues to increase the angle-of-attack on the slowly rotating blades, making recovery virtually impossible, even with full down collective.

When the rotor stalls, it does not do so symmetrically because any forward airspeed of the helicopter will produce a higher airflow on the advancing blade than on the retreating blade. This causes the retreating blade to stall first, allowing it to dive as it goes aft while the advancing blade is still climbing as it goes forward. The resulting low aft blade and high forward blade become a rapid aft tilting of the rotor disc sometimes referred to as "rotor blow-back". Also, as the helicopter begins to fall, the upward flow of air under the tail surfaces tends to pitch the aircraft nose-down. These two effects, combined with aft cyclic by the pilot attempting to keep the nose from dropping, will frequently allow the rotor blades to blow back and chop off the tailboom as the stalled helicopter falls. Due to the magnitude of the forces involved and the flexibility of rotor blades, rotor teeter stops will not prevent the boom chop. The resulting boom chop, however, is academic, as the aircraft and its occupants are already doomed by the stalled rotor before the chop occurs.

Safety Notice SN-29

Issued: Mar 93 Rev: Jun 94

AIRPLANE PILOTS HIGH RISK WHEN FLYING HELICOPTERS

There have been a number of fatal accidents involving experienced pilots who have many hours in airplanes but with only limited experience flying helicopters.

The ingrained reactions of an experienced airplane pilot can be deadly when flying a helicopter. The airplane pilot may fly the helicopter well when doing normal maneuvers under ordinary conditions when there is time to think about the proper control response. But when required to react suddenly under unexpected circumstances, he may revert to his airplane reactions and commit a fatal error. Under those conditions, his hands and feet move purely by reaction without conscious thought. Those reactions may well be based on his greater experience, ie., the reactions developed flying airplanes.

For example, in an airplane his reaction to a warning horn (stall) would be to immediately go forward with the stick and add power. In a helicopter, application of forward stick when the pilot hears a horn (low RPM) would drive the RPM even lower and could result in rotor stall, especially if he also "adds power" (up collective). In less than one second the pilot could stall his rotor, causing the helicopter to fall out of the sky.

Another example is the reaction necessary to make the aircraft go down. If the helicopter pilot must suddenly descend to avoid a bird or another aircraft, he rapidly lowers the collective with very little movement of the cyclic stick. In the same situation, the airplane pilot would push the stick forward to dive. A rapid forward movement of the helicopter cyclic stick under these conditions would result in a low "G" condition which could cause mast bumping, resulting in separation of the rotor shaft or one blade striking the fuselage. A similar situation exists when terminating a climb after a pull-up. The airplane pilot does it with forward stick. The helicopter pilot must use his collective or a very gradual, gentle application of forward cyclic.

To stay alive in the helicopter, the experienced airplane pilot must devote considerable time and effort to developing safe helicopter reactions. The helicopter reactions must be stronger and take precedence over the pilot's airplane reactions because everything happens faster in a helicopter. The pilot does not have time to realize he made the wrong move, think about it, and then correct it. It's too late; the rotor has already stalled or a blade has already struck the airframe and there is no chance of recovery. To develop safe helicopter reactions, the airplane pilot must practice each procedure over and over again with a competent instructor until his hands and feet will always make the right move without requiring conscious thought. **AND, ABOVE ALL, HE MUST NEVER ABRUPTLY PUSH THE CYCLIC STICK FORWARD.**

Also see Safety Notices SN-11 and SN-24

Safety Notice SN-32

Issued: March 1998

Revised: May 2013; Feb 2016

HIGH WINDS OR TURBULENCE

Flying in high winds or turbulence should be avoided.

A pilot's improper application of control inputs in response to turbulence can increase the likelihood of a mast bumping accident. If turbulence is encountered, the following procedures are recommended:

1. Reduce power and use a slower than normal cruise speed. Mast bumping is less likely at lower airspeeds.
2. For significant turbulence, reduce airspeed to 60–70 knots.
3. Tighten seat belt and rest right forearm on right leg to minimize unintentional control inputs. Some pilots may choose to apply a small amount of cyclic friction to further minimize unintentional inputs.
4. Do not overcontrol. Allow aircraft to go with the turbulence, then restore level flight with smooth, gentle control inputs. Momentary airspeed, heading, altitude, and RPM excursions are to be expected.
5. Avoid flying on the downwind side of hills, ridges, or tall buildings where turbulence will likely be most severe.

The helicopter is more susceptible to turbulence at light weight. Reduce speed and use caution when flying solo or lightly loaded.

Appendix 7: Robinson R22 and R44 ADs and SFAR 73

Issue date	Reference	Significant points
12 Jan 1995	FAA priority letter AD 95-02-03	Introduces changes to R22 flight manual to limit operations in high winds, turbulence and wind shear conditions and provides recommendations to avoid M/R (main rotor) stalls and mast-bumping.
17 Mar 1995	FAA AD 95-04-14 [Applies to R22 helicopters only. R44 not affected]	<p>Formalises the priority letter but adds some minor changes to wording. Intended to revise the operating limitation of the helicopter to a safer level and applies to all pilots. Prohibited flight in the R22 helicopter when:</p> <ul style="list-style-type: none"> • surface wind exceeds 25 knots or gust spread exceeds 15 knots • wind shear exists • moderate or worse turbulence is encountered; continued flight is prohibited. <p>Limit air speed to between 60 knots and 0.7 Vne if inadvertently encountering turbulence.</p> <p>Adds to normal procedures description of M/R stall and mast-bumping conditions and how to avoid. Recommends max Vne is 90% rated and avoid flight at high-density altitudes, use maximum power-on at all times. Adds to emergency procedures with actions if experiencing low-G or turbulence.</p>
25 Mar 1995	CAA DCA/R22/27	AD 95-04-14 is inserted directly into New Zealand flight manual for R22 and compliance with 'Limitations' section is mandatory.
27 Mar 1995 to 31 Dec 1997	FAA SFAR 73	<p>Establishes special training requirements for R22 and R44 pilots (Robinson Safety Awareness Training). Confirms that R22 is used for training and describes the hazards of low-G and M/R stall. Justifies the requirement for an experience threshold for the Robinson pilots.</p> <ul style="list-style-type: none"> • States that no person may <u>manipulate the controls</u> of an R22 or R44 before completing the Robinson safety awareness training. This also applies to pilots with existing helicopter licences. • Describes subject matter in Robinson safety awareness training. • Describes requirements for instructors to be authorised to conduct Robinson safety awareness training. <p>Additionally, <u>no person may act as pilot in command</u> in an R22 unless that person has:</p> <ul style="list-style-type: none"> • at least 200 hours' helicopter total time, of which at least 50 must be in the R22 • or 10 hours' dual and endorsement from an authorised instructor that the pilot is proficient to act as pilot in command. In this case the pilot must also

Issue date	Reference	Significant points
		<p>be subject to an annual flight review instead of two-yearly until meets minimum experience limit.</p> <p>A person with a pilot's licence but not for rotor craft must have a minimum of 20 hours' dual in R22 before going solo plus a log book endorsement from an appropriately rated instructor that the person is proficient to solo an R22. This endorsement only remains valid for 90 days.</p> <p>Robinson safety awareness training must be repeated every two years.</p> <p>Flight reviews must be carried out in the applicable R22 or R44 and include a review of the theory and practical skills central to Robinson safety awareness training.</p>
14 Jul 1995	FAA AD 95-11-09 for R22 and AD 95-11-10 for R44	Low 'G' cyclic pushover manoeuvres prohibited.
14 Sep 1995	CAA GEN A113/95	<p>Implements Robinson special training requirements for all persons who seek to manipulate the controls or act as pilot in command of a Robinson R22 and R44 helicopter.</p> <p>Repeats SFAR 73 in a clearer format and in addition to any existing Part 61 requirements.</p> <p>Has not been transferred into subsequent amendments of rules Part 61. No longer in force.</p>
26 Jan 1996 (permanent)	FAA AD 95-26-04 For R22 helicopters and FAA AD 95-26-05 Issued for R44 with same conditions.	<p>Supersedes AD 95-04-14 with minor changes after feedback. Applies to pilot 'manipulating the controls', who must have also completed the Robinson safety awareness training.</p> <p>Repeats the same conditions as previous AD for prohibiting flight in wind or turbulence but now only applies to pilots with less than the minimum R22/R44 experience. The limits for high-altitude flight and wind shear are removed.</p> <p>The new conditions for operations in wind or turbulence are highlighted in yellow.</p> <p>Unless the person <u>manipulating the controls</u> in an R22/R44 has at least 200 hours' helicopter total time, of which at least 50 must be in the R22/R44, they are prohibited from flying the R22/R44 helicopter when:</p> <ul style="list-style-type: none"> • surface wind exceeds 25 knots or • the gust spread exceeds 15 knots. <p>If moderate turbulence or worse is encountered, continued flight is prohibited.</p> <p>All pilots must limit air speed to between 60 knots and 0.7 Vne if inadvertently encountering turbulence.</p>

Issue date	Reference	Significant points
		<p>Adds to normal procedures a description of M/R stall and mast-bumping conditions and how to avoid. The avoidance actions are:</p> <ol style="list-style-type: none"> 1. Maintain cruise speed between 60 knots and less than 90% of rated Vne 2. Use max power-on at all times during powered flight. 3. Avoid sideslip and maintain trimmed flight at all times. 4. Avoid large, rapid forward cyclic movements in forward flight and abrupt control inputs in turbulence. 5. Add to the 'Emergency' procedures how to react to low-G and turbulence.
16 Feb 1996	CAA DCA/R22/27A DCA/R44/2A	<p>Revises New Zealand flight manual for R22/R44 by:</p> <ul style="list-style-type: none"> • adding one page of CAA text to the 'Limitations' section. Compliance mandatory • inserting the AD 95-26-04 Normal and Emergency sections.
31 Dec 1997 to 31 Dec 2002	FAA SFAR 73-1	<p>Clarifies the previous version with replacement text after feedback and, as the FAA recognises that the R44 is more stable than the R22, experience in the R22 can be credited towards the minimum requirement for the R44.</p> <p>Extends the SFAR validity to 2002.</p>
28 Aug 1998	CAA DCA/R22/27B DCA/R44/2B	<p>Revises New Zealand flight manual for R22/R44 by:</p> <ul style="list-style-type: none"> • adding three pages of CAA text to the 'Limitations' section. Compliance mandatory • inserting the AD 95-26-04 Normal and Emergency sections.

31 Dec 2002 to 31 Mar 2008	FAA SFAR 73-1	<p>Considers feedback from industry on several points.</p> <ol style="list-style-type: none"> 1. Should the R44 be excluded? No, it must remain covered by this SFAR. 2. Should flight training be allowed for ab-initio pilots before completing the Robinson safety awareness training? No, decided that continuous awareness training was preferable as the student was able to absorb it. 3. Should the annual flight review be extended to the normal two years? No, it is to remain at one year as described in the SFAR for pilots with experience less than the minimum level. 4. Should the 200-hour limit be reduced to 150? No. 5. Should the life of this SFAR only be extended two years? No. <p>Extends the SFAR to 2008.</p>
6 Jul 2004 25 Nov 2004	AD 95-26-05 R1 FAA CAA DCA/R44/3C	<p>FAA rescinds AD 95-26-05 for R44 helicopters.</p> <p>CAA Cancels R44 limitations and safety awareness training in New Zealand by removing the three pages from the New Zealand R44 flight manual 'Limitations' section.</p>
26 Jul 2007	CAA DCA/R22/27C	<p>Revises New Zealand flight manual for R22 by:</p> <ul style="list-style-type: none"> • replacing three pages of CAA text into the 'Limitations' section that includes some of the general content of SFAR 73. Compliance mandatory • inserting the AD 95-26-04 Normal and Emergency sections.
31 Mar 2008 to 30 Jun 2009	FAA SFAR 73	The SFAR is reformatted to be more readable and extended to 2009, but the content is unchanged.
29 June 2009 Permanent	FAA SFAR 73-2	Reviews the NTSB accident data between 2005 and 2008 and finds there were nearly four times more R22/ R44 than other two-bladed light helicopters. Per 100,000 hours of flight time, the accident rate for the R22/ R44 is 10.48 compared with 7.44 for the other types taken as a group, therefore justifying continuing with the Robinson safety awareness training as required under SFAR 73. Decides to make SFAR 73 permanent.
23 April 2015 26 May 2016	CAA DCA/R22/48 DCA/ R44 /34	<p>Publishes Robinson helicopter fleet consultation document.</p> <p>Revises R22 and R44 (see Appendix 9) flight manual 'Limitations' section to include ongoing safety awareness training and increased experience requirements before flying solo. R22 flight manual limitations include wind limitations for low-time pilots, R44 does not. R66 unchanged.</p>

Speeds in Excess of 70 Knots (normal cruise)

Figure 1

Blue line – tail rotor thrust
 Red line – centre of gravity

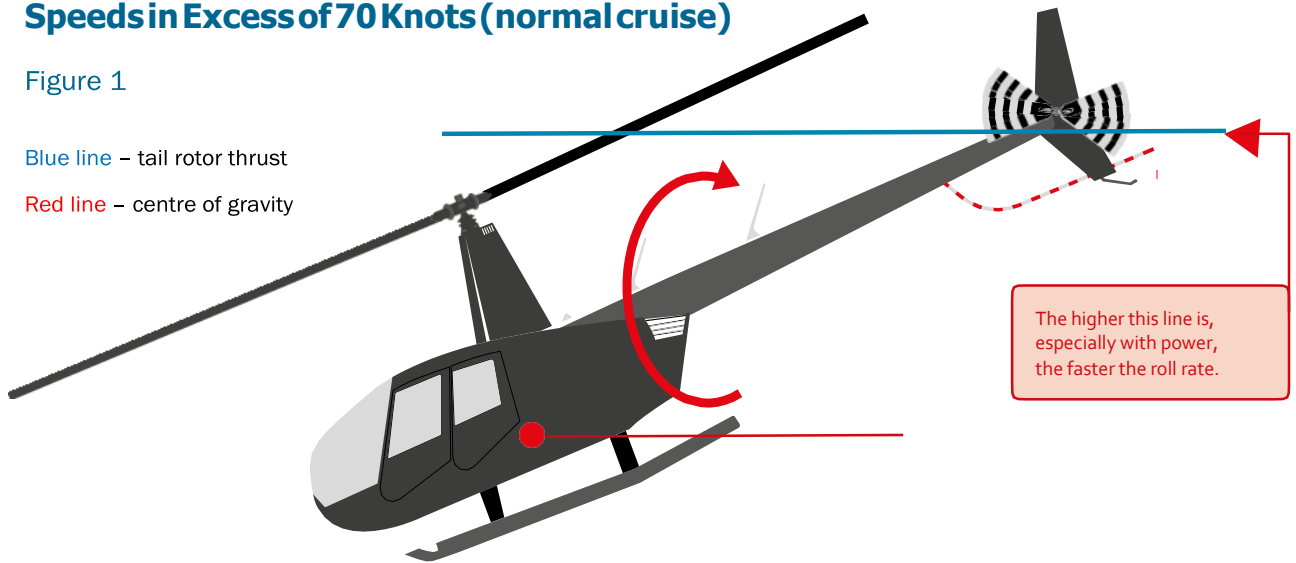

The higher this line is, especially with power, the faster the roll rate.

The helicopter encounters a low-G condition while in a normal nose-down (tail-high) cruise. The faster the speed, the higher the tail will be.

The tail rotor thrust (blue line) is well above the centre of gravity (red line). This produces a large rolling moment on the fuselage to the right.

The rotor disc does not follow the fuselage, as it is unloaded.

A mast-bump occurs when the teeter limit is reached. When the blade spindles contact the mast, a massive failure results.

Speed Reduced to 60–70 Knots

Figure 2

Blue line – tail rotor thrust
 Red line – centre of gravity

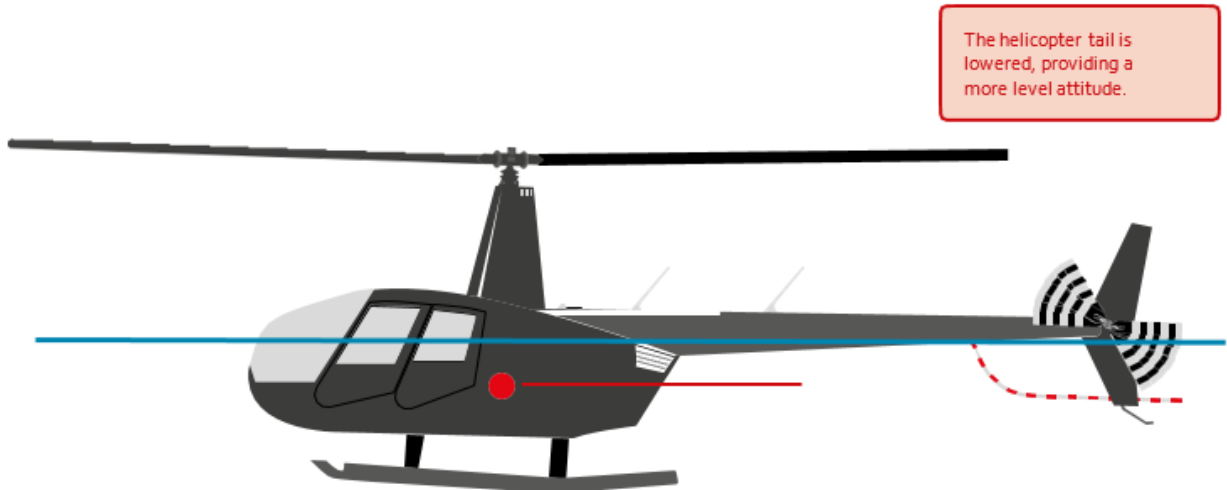

The helicopter tail is lowered, providing a more level attitude.

The tail rotor thrust is now much closer to the centre of gravity. If turbulence and low G occurs, this reduces the right roll.

CAA APPROVED
AIR 2479
AIR 2821
26.05.16

LIMITATIONS SECTION*

1. Purpose

To apply conditions issued under section 21(1)(c) of the Civil Aviation Act 1990, for the training (Robinson Safety Awareness Training) of persons that the Director of Civil Aviation considers necessary for the safe operation of Robinson R44 helicopters.

2. Applicability

These conditions apply to any person acting as pilot-in-command of a Robinson R44 helicopter, whether as a student pilot or a holder of a private pilot or commercial pilot licence.

These conditions impose requirements on the delivery of Robinson safety awareness training by holders of air operator certificates and holders of aviation training organisation certificates.

For pilots, these conditions must be complied with in full prior to any person piloting a Robinson R44 helicopter.

3. Transitional Provisions

(a) Before 30 June 2016 a student pilot is not required to comply with—

(1) section 4 of these conditions but

(2) must comply with any existing training requirements under rule 61.105 of the Civil Aviation Rules.

(b) Before 31 December 2016 a holder of a private pilot licence (helicopter) or a commercial pilot licence (helicopter) engaged in operations for hire or reward is not required to comply with—

(1) section 5 of these conditions but

*These pages are inserted by NZ AD DCA/R44/34.

- (2) must comply with any existing training requirements for a helicopter type rating under rule 61.153 or rule 61.203 of the Civil Aviation Rules.
- (c) Before 30 June 2017 a holder of a recreational pilot licence (helicopter), a private pilot licence (helicopter) or a commercial pilot licence (helicopter) engaged in operations that are not for hire or reward is not required to comply with—
 - (1) section 5 of these conditions but
 - (2) must comply with any existing training requirements for a helicopter type rating under rule 61.153 or rule 61.203 of the Civil Aviation Rules
- (d) Before 30 June 2016 a holder of an air operator certificate or an aviation training organisation certificate is not required to comply with—
 - (1) section 6 of these conditions but
 - (2) must comply with any existing training requirements under Part 119 or Part 141 of the Civil Aviation Rules.

4. Student pilots

These requirements apply to a person who has no experience flying a helicopter.

- (a) A person must not manipulate the controls of a Robinson R44 helicopter unless the person has satisfactorily completed training in the relevant topics of the ground component of the Robinson safety awareness training syllabus specified in paragraph 6(c)(1).
- (b) A person must not fly solo in a Robinson R44 helicopter unless the person—
 - (1) has satisfactorily completed the full ground and in-flight components of the Robinson safety awareness training specified in paragraph 6(c) within the preceding 90 days; and
 - (2) has completed 20 hours of dual instruction in a Robinson R44 helicopter that—

(i) may include up to 10 hours of flight time in a Robinson R22 helicopter; and

(ii) must not include cross country flight time.

5. Helicopter pilot licence holders

These requirements apply to a holder of a recreational pilot licence (helicopter), a private pilot licence (helicopter) or a commercial pilot licence (helicopter).

(a) To be eligible for a Robinson R44 helicopter type rating, a person must have—

(1) received at least 3 hours of dual instruction on the helicopter; and

(2) satisfactorily completed the full ground and in-flight components of the Robinson safety awareness training specified in paragraph 6(c).

(b) Before acting as pilot-in-command of a Robinson R44 helicopter, a person must have satisfactorily completed the full ground and in-flight components of the Robinson safety awareness training specified in paragraph 6(c) within the previous 24 months.

(c) Completion of the training required by paragraphs (b) and (c) must be endorsed in the pilot logbook by the instructor who conducted the training.

6. Robinson safety awareness training

(a) Robinson safety awareness training must be acceptable to the Director and conducted by—

(1) the holder of an air operator certificate or an aviation training organisation certificate if the certificate authorises such training; or

(2) the Robinson Helicopter Company.

(b) An instructor providing training under paragraph (a) must—

(1) hold a category A or B instructor rating; and

(2) have at least 200 hours flight time experience on helicopters, of which at least 50 hours must have been a Robinson R22 or R44 helicopter; and

(3) be approved by a general aviation flight examiner who—

(i) operates under the authority of an air operator certificate or aviation training organisation certificate; and

(ii) holds the privilege to assess instructors conducting Robinson safety awareness training.

(c) Robinson safety awareness training consists of the following—

(1) the ground component which must cover the following topics:

(i) energy management:

(ii) mast bumping:

(iii) low rotor RPM blade (rotor) stall:

(iv) low G hazards:

(v) rotor RPM decay:

(vi) flight into turbulence:

(vii) review of RHC safety notices; and

(2) the in-flight component which must cover the following topics:

(i) enhanced training in auto rotational procedures:

(ii) low rotor RPM recognition and recovery.

(d) Low G hazard training must not be demonstrated or practiced in flight.

CAUTION

Low G hazards training shall NOT under any circumstances be demonstrated or practised in the air.

- (e) Instructors giving basic training or type ratings to persons operating an R44 helicopter should use discretion and provide Robinson safety awareness training commensurate with the experience of the student pilot.
- (f) A student pilot should be given a briefing on the topics that need to be covered during Robinson safety awareness training, to provide the student pilot with an adequate understanding of the essential elements of the training prior to manipulating the controls. As the student pilot progresses, the level of the training should progressively increase so that the student pilot covers all of these requirements prior to the student pilot acting as pilot-incommand.
- (g) When Robinson safety awareness training has been completed by the pilot in command of a Robinson R44 helicopter within the previous 24 months, a record of this training must be endorsed by the instructor in the pilot's logbook as having been completed. Robinson safety awareness training may be conducted concurrently with a Biennial Flight Review, however, the "Inflight" component of Robinson safety awareness training is specific to the Robinson R44 Helicopter.
- (h) Only approved Part 119 air operator certificate holders and Part 141 aviation training organisations will deliver a CAA approved course of training and approved examination in support of Robinson safety awareness training. Completion of this training and examination must be recorded in the candidate pilot's logbook.

Appendix 10: Low-G mast-bumping and in-flight break-up sequence



Right roll after entering low-G conditions.



Nose drops after teeter stops contacted.



Rotor divergence after pitch links fail.



Main rotor strikes cabin and skid.

ROBINSON HELICOPTER COMPANY

2901 Airport Drive, Torrance, California 90505

Phone (310) 539-0508 Fax (310) 539-5198

SAFETY ALERT

Issued: 18 Nov 2016

LOW-G MAST BUMPING ACCIDENTS

Despite improvements in awareness and training over the past 20 years, there continue to be low-G mast bumping accidents in Robinson helicopters. This type of accident is entirely avoidable by using good pilot judgment and adhering to the following operating procedures:

- Always avoid cyclic pushover maneuvers which could cause low-G, particularly following a cyclic pull-up. Initiate descents with collective, not forward cyclic. Remember, low-G pushovers are prohibited maneuvers in Robinson helicopters.
- If low-G (a lightweight feeling) does occur, apply gentle aft cyclic as soon as you recognize it. Do not wait for a right roll to begin. Low-G induced right roll indicates you are losing control of the helicopter.
- Do not over-react to turbulence. The helicopter rides turbulence quite well if your control inputs are relaxed and gentle.
- Slow down in turbulence. Also, slow down in the following situations:
 - o Any time your full attention is not focused on aircraft control, for example when tuning avionics or having conversations with passengers.
 - o During primary instruction or transition training.

Just as with automobiles, aircraft controls are more sensitive at high speed. Slowing down increases the safety margin against inadvertent or incorrect inputs and allows the time necessary for pilot reactions if corrective inputs are required. Additional time is particularly important during training because of a potential delay when transferring control from student to instructor.

R44 and R66 helicopters are capable of high cruise speeds, especially when lightly loaded. A yellow precautionary operating range has been added to R44 and R66 airspeed indicators as a reminder to slow down for safety. The yellow arc indicates the maximum recommended cruise speed is 110 KIAS. Speeds above 110 KIAS are not recommended except in smooth air with the pilot's attention fully focused on flying.

REVIEW SAFETY NOTICES SN-11, SN-29, AND SN-32

LOW-G MAST BUMPING ACCIDENTS ARE PREVENTABLE

Appendix 12: Watchlist item

Robinson helicopters: mast bumping accidents in NZ

What is the problem?

The Transport Accident Investigation Commission is concerned about the number of accidents in New Zealand in which Robinson helicopters have experienced ‘mast bumping’. These accidents have raised concerns about the risks of flying these helicopters in the mountainous terrain and weather conditions that are common in New Zealand.

Mast bumping is contact between an inner part of a main rotor blade or a rotor hub and the main rotor drive shaft (or ‘mast’). Mast bumping usually results in the helicopter breaking up in flight, which is fatal for those on board.

Part of the problem is that the available evidence has not allowed the circumstances and causes of all of these ‘mast bumping’ accidents to be fully determined. However, a significant proportion have been found to have occurred in “low-G”⁸⁰ flight conditions. Helicopters with semi-rigid two-bladed main

rotor systems, as used on Robinson helicopters, are particularly susceptible to mast bumping in “low-G” conditions. Low-G can be caused by large or abrupt flight control inputs or by turbulence. The risk of mast bumping in turbulence increases with high power settings and operating at high speed and light weight.

What is the solution?

Operators must select a type of aircraft suited to the risk profile of the intended use. Similarly, all pilots must understand the helicopter’s operating limitations, avoid circumstances which could see these inadvertently exceeded, and receive proper training in the causes, dangers, and prevention of mast bumping, including in low-G conditions. It is particularly important for Robinson pilots to be aware of the risks of flying a lightly loaded helicopter at high speed in turbulence. Prohibitions against in-flight low-G demonstrations must be observed, and low-G recovery training must be conducted on the ground.

The regulatory environment must:

- support high quality training and improved pilot awareness of mast bumping risks, including in low-G conditions
- require the manufacturer to clearly state the limitations of the helicopters
- encourage use of the helicopter as appropriate to the operating conditions.

Further research should be undertaken into the factors that can lead to mast bumping.

A requirement for cockpit video recorders and/or other means of data capture would provide useful data to investigations.

Background

Robinson helicopters are relatively inexpensive to purchase and cost effective to operate; and are therefore popular. About 300 are registered in New Zealand, mostly R22 and R44 models, with a small number of turbine-powered, 5-seat R66 models. These are used for flight training, agricultural, tourism,

⁸⁰ A low-G condition occurs when an object is subjected to a net vertical force less than the force of gravity. When the vertical force is zero, the object is described as being ‘weightless’.

and commercial operations. All Robinson helicopter pilot operating handbooks state that pilots should avoid flying in high winds or turbulence, and subjecting the helicopter to low-G conditions.

Since 1996 the Commission or the Civil Aviation Authority (CAA) have investigated fourteen mast bumping accidents or incidents involving Robinson helicopters, including nine where low-G mast bumping is known to have occurred. Six of these were in the past four years. Eighteen people have died in all these accidents, including nine in known low-G mast bumping accidents. The low-G related rate in New Zealand is considerably higher than in other parts of the world⁸¹. The Commission's inquiries have issued safety recommendations that remain open.

Mast bumping is contact between an inner part of a main rotor blade or a rotor hub and the main rotor drive shaft. Helicopters with the semi-rigid two-bladed rotor systems used on Robinson helicopters are susceptible to mast bumping during low-G flight conditions. Mast bumping usually results in the helicopter breaking up during flight, which is fatal for those on board. For this reason, it is often difficult to determine exactly what happened to cause the mast bump.

Low-G conditions can arise in turbulence. Significant areas of New Zealand terrain are mountainous, and they are often exposed to strong wind. Therefore, New Zealand pilots are more likely to encounter turbulence than in some other parts of the world where Robinson helicopters are used. Pilots must be aware of how hazardous it can be to operate Robinson helicopters in moderate or greater turbulence.

Instructors and pilots must be clear in their understanding of the hazards of operating semi-rigid two-bladed helicopters in low-G conditions, and how inadvertent or improper flight control inputs can cause mast bumping. Low-G recovery training must be conducted as ground training only.

The Commission also identified that the rate of Robinson helicopter in-flight break-up accidents in New Zealand had not been significantly reduced by New Zealand's adoption of the Federal Aviation Administration (FAA) measures intended to help prevent such accidents. We also found the format of the Robinson helicopter flight manuals and their terminology did not draw enough attention to safety critical instructions and conditions that could result in serious injury or death.

We recommended that the CAA:

- conduct a review of Robinson safety awareness training in New Zealand and facilitate the development and adoption of best practice across the sector, including a level of consistency in the way instructors deliver the safety awareness training.
- review FAA SFAR 73 [Special Federal Aviation Regulation 73, which mandated special safety awareness training for all R22 and R44 pilots and set a threshold for minimum pilot experience] in the context of the New Zealand aviation system and adopt relevant improvements that would likely enhance the operational safety of Robinson helicopters in New Zealand.
- include the knowledge and training requirements of Special Federal Aviation Regulation No. 73, or an equivalent requirement, as a prerequisite for the issue of a Robinson R66 type rating.
- promptly publicise the recent changes to the Robinson R66 (and R44) Pilot's Operating Handbooks that caution against flight in high winds and turbulence, and which advise pilots to reduce power and speed if turbulence is expected or encountered.

In response, the CAA reviewed Robinson safety awareness training in New Zealand, and it has since clarified training requirements for pilots of the R22 and R44 helicopters. The CAA decided not to include the R66 in the safety awareness training, saying that the FAA had rejected the inclusion of the R66 in SFAR 73, and that it would monitor advice from Robinson Helicopters and the FAA⁸².

⁸¹ For instance, the low-G mast bumping accident rate in New Zealand compared with the United States is about nine times higher. This is based on fleet size of about 300 compared to 2700, and the same number of low-G mast bumping accidents in each market since the year 2000 (data provided by Robinson Helicopters). Variations in types of use or average hours flown may explain some of this difference.

⁸² The CAA and the FAA signed a Bilateral Aviation Safety Agreement (BASA) in 2002, which included enhanced cooperation and efficiency, and reciprocal acceptance of airworthiness approvals.

In May 2016, the Commission released its report into a mast bump and the in-flight break up of a Robinson R66 helicopter in the Kaweka Range in 2013⁸³. One of the recommendations from the inquiry into that accident was that the FAA reinstate research into the dynamic behaviour of the Robinson's rotor system under conditions of low-G.

The FAA and Robinson had conducted post-certification flight testing in 1982 (for the R22), 1995 (for the R44), and 2014 (for the R66), which included limited low-G manoeuvres. Due to the dangers of low-G, it is not possible to investigate more severe conditions with test pilot flying. However, computational sciences and aerospace engineering have advanced to such a degree that a fuller understanding of the dynamic behaviour of the Robinson and other semi-rigid two-bladed rotor systems should now be possible.

Following an R44 accident⁸⁴, the Commission has further recommended that the CAA and Secretary of Transport promote, through the International Civil Aviation Organization, the need for cockpit video recorders and/or other means of data capture in certain classes of helicopter. This action could help better determine why these accidents happen. The CAA has accepted this recommendation and agreed to initiate an assessment paper on the issue.

The Commission's recommendations are seeking concerted actions by regulatory authorities, the manufacturer, operators, instructors and pilots to promote the safe operation of Robinson helicopters in the New Zealand environment; and to better understand the helicopter's operating characteristics and the factors that can lead to mast bumping.

Version history

This Watchlist item was first published in October 2016. The Ministry of Transport, New Zealand Civil Aviation Authority, National Transportation Safety Board (US), Federal Aviation Administration (US), and the Robinson Helicopter Company were consulted during its preparation.

⁸³ Transport Accident Investigation Commission *Report 13-003: Robinson R66, ZK-IHU, Mast bump and In-flight break-up, Kaweka Range, 9 March 2013*. Open safety recommendations 002/16, 004/16, 005/16, and 011/16
http://www.taic.org.nz/ReportsandSafetyRecs/AviationReports/tabid/78/ctl/Detail/mid/482/InvNumber/2013-003/language/en-US/Default.aspx?SkinSrc=%5BG%5Dskins%2FtaicAviation%2Fskin_aviation

⁸⁴ Transport Accident Investigation Commission *Report 15-002: Mast bump and in-flight break-up, Robinson R44, ZK-IPY Lochy River, near Queenstown, 19 February 2015* Open safety recommendations 014/16 and 015/16
[http://www.taic.org.nz/ReportsandSafetyRecs/AviationReports/tabid/78/ctl/Detail/mid/482/InvNumber/2015-002/Page/0/language/en-NZ/Default.aspx?SkinSrc=\[G\]skins%2ftaicAviation%2fskin_aviation](http://www.taic.org.nz/ReportsandSafetyRecs/AviationReports/tabid/78/ctl/Detail/mid/482/InvNumber/2015-002/Page/0/language/en-NZ/Default.aspx?SkinSrc=[G]skins%2ftaicAviation%2fskin_aviation)



**Recent Aviation Occurrence Reports published by
the Transport Accident Investigation Commission
(most recent at top of list)**

- 11-007 Descent below instrument approach minima, Christchurch International Airport, 29 October 2011
- 11-006 Britten-Norman BN.2A Mk.III-2, ZK-LGF, runway excursion, Pauanui Beach Aerodrome, 22 October 2011
- 11-003 In-flight break-up ZK-HMU, Robinson R22, near Mount Aspiring, 27 April 2011
- 12-001 Hot-air balloon collision with power lines, and in-flight fire, near Carterton, 7 January 2012
- 11-004 Piper PA31-350 Navajo Chieftain, ZK-MYS, landing without nose landing gear extended, Nelson Aerodrome, 11 May 2011
- 11-005 Engine compressor surges, 18 September 2011
- 11-001 Bell Helicopter Textron 206L-3, ZK-ISF, Ditching after engine power decrease, Bream Bay, Northland, 20 January 2011
- 11-002 Bombardier DHC-8-311, ZK-NEQ, Landing without nose landing gear extended Woodbourne (Blenheim) Aerodrome, 9 February 2011
- 10-010 Bombardier DHC-8-311, ZK-NEB, landing without nose landing gear extended, Woodbourne (Blenheim) Aerodrome, 30 September 2010
- 12-001 Interim Factual: Cameron Balloons A210 registration ZK-XXF, collision with power line and in-flight fire, 7 January 2012
- 10-009 Walter Fletcher FU24, ZK-EUF, loss of control on take-off and impact with terrain, Fox Glacier aerodrome, South Westland, 4 September 2010
- 10-007 Boeing 737-800, ZK-PBF and Boeing 737-800, VH-VXU airspace incident, near Queenstown Aerodrome, 20 June 2010
- 10-005 Cessna A152, ZK-NPL and Robinson R22 Beta, ZK-HIE near-collision. New Plymouth Aerodrome, 10 May 2010
- 10-003 Cessna C208 Caravan ZK-TZR engine fuel leak and forced landing, Nelson, 10 February 2010
- 10-006 Runway Incursion, Dunedin International Airport, 25 May 2010

Price \$27.00

ISSN 1179-9080 (Print)
ISSN 1179-9099 (Online)